

# Hobie 16 Assembly Manual





## TABLE OF CONTENTS

	Page
Parts Layout .....	2
Knots to Use .....	2
Framing the Hulls .....	4
Trampoline .....	5
Rudder & Tiller System .....	7
Mast & Rigging .....	8
Stepping the Mast .....	10
Trapeze Wires .....	13
Mainsail .....	14
Mainsheet System .....	16
Jib Sail .....	18
Righting .....	20
Trapeze Use .....	22
Reefing .....	24
Safety .....	26
Parts List .....	27
Maintenance Mooring, Trailing .....	30

**IMPORTANT NOTICE.** This manual is devoted to increasing your safety and enjoyment of your Hobie Cat. We ask that you read it all thoroughly and **TRY OUR WAY FIRST!** Please pay particular attention to the Safety section and the Maintenance, Mooring, and Trailing sections. It would also be a good practice to review these on a periodic basis.

**DANGER!!** Watch for overhead wires whenever you are sailing, launching, or trailering with the mast up. The mast sticks up there a long way and shock or death could result if it comes in contact with overhead wires. So look up when moving the boat around or even stepping the mast and give any wires a wide berth.

# PARTS LAYOUT

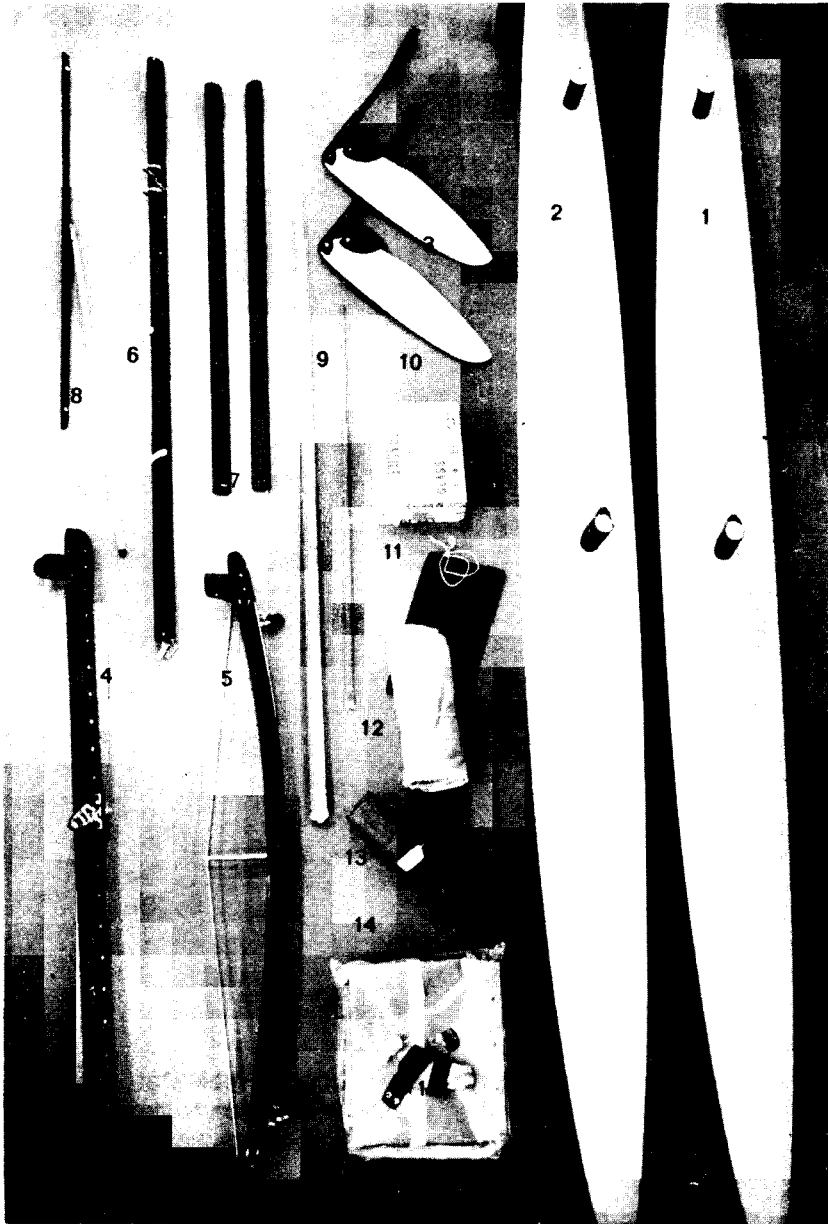

## MAJOR COMPONENTS

1. Port Hull
2. Starboard Hull
3. Rudder Assemblies
4. Aft Crossbar
5. Forward Crossbar
6. Boom
7. Sidebars
8. Tiller Extension and Crossbar Assembly
9. Battens: Main & Jib
10. Rig Kit
11. Sail Bag
12. Mainsail
13. Jib
14. Trampoline
15. Mast (not shown)

FIGURE 1

## KNOTS TO USE

FIGURE 8 KNOT

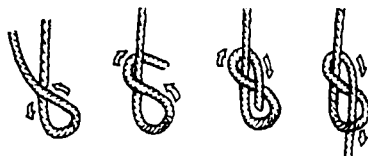

BOWLINE KNOT

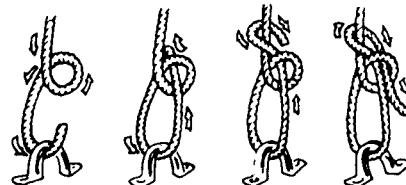

17.

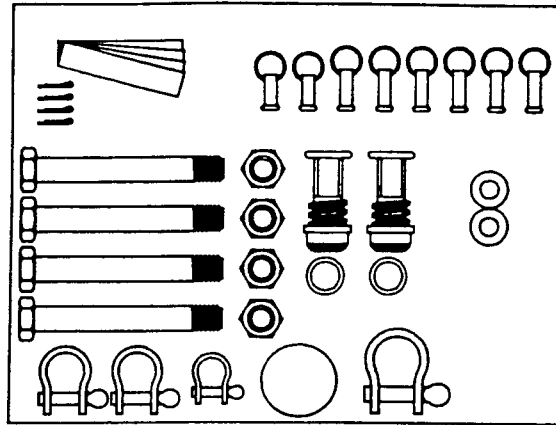

**RIG KIT**

17. Parts Card #1

18. Parts Card #2

20. Mainsheet System

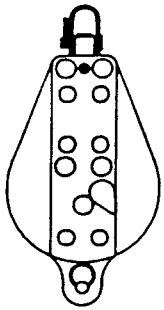

20.

18.

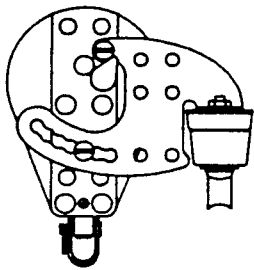
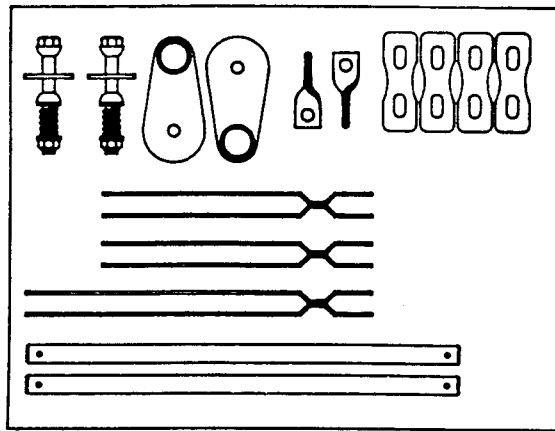

**FIGURE 2**

**WIRE SET**

23. Bridles

24. Shrouds, Forestay, & Jib Halyard Assembly

25. Trapeze Wire Shock Cord

26. Trapeze Wires

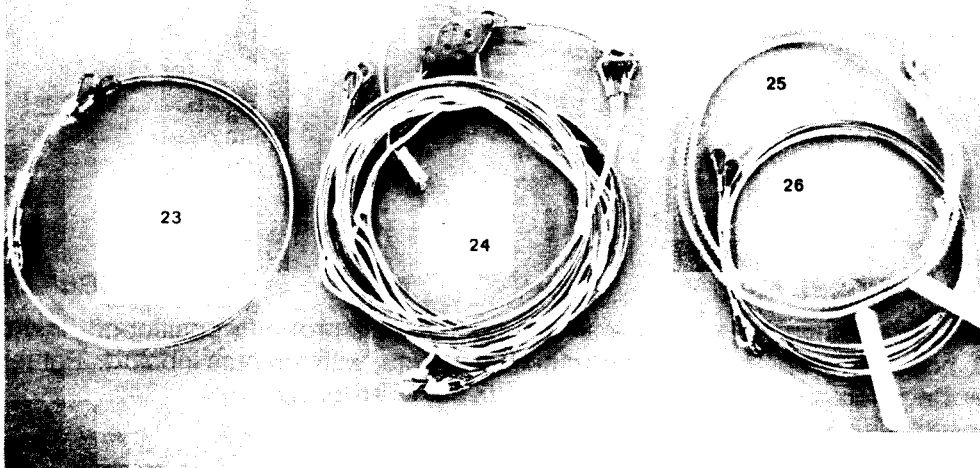

**FIGURE 3**

# FRAMING THE HULLS

*Tools needed: Rubber mallet, adjustable crescent wrench, screwdriver, and pliers.*

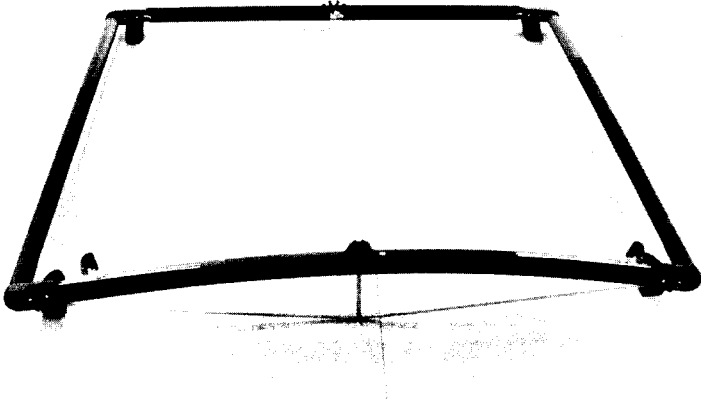

**FIGURE 4**

Assemble the frame components as shown in the photo. The flared portion of the sidebar track must be forward and facing inward.

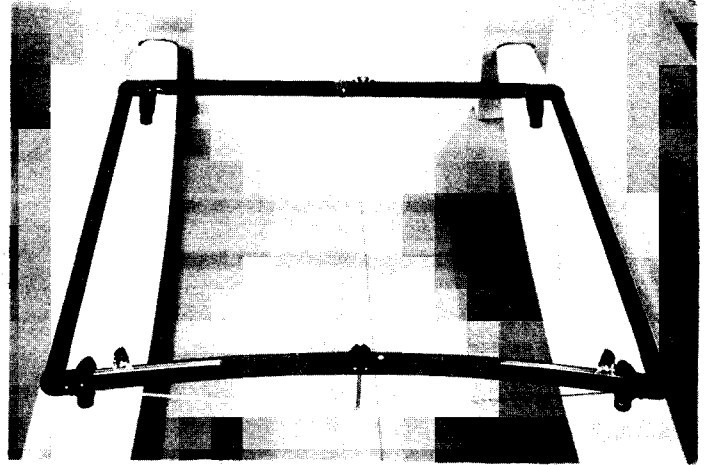

**FIGURE 5**

With an assistant, position the hulls as shown, using the packing carton end caps for assembly stands. Make sure that the flatter sides of the hulls face outward. Carefully place the frame on the pylons, aligning it so that each corner casting in turn can be started onto its pylon. Do not drive the castings down until all have been equally started.

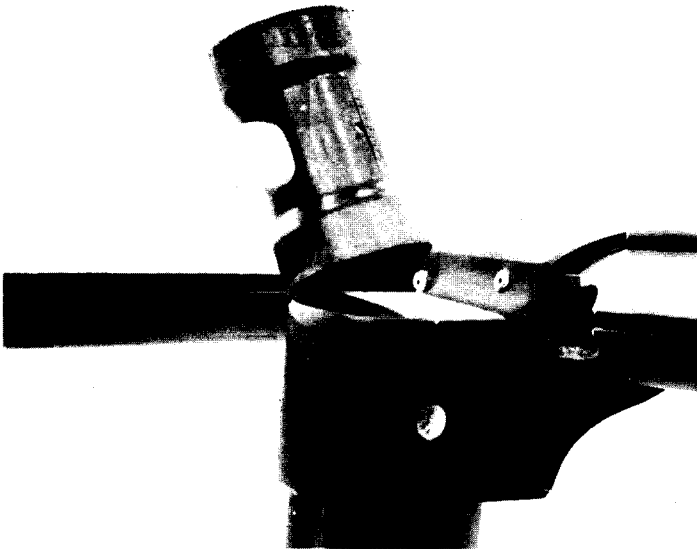

**FIGURE 6**

Beginning at the left front, drive each corner casting down onto the pylon until the bolt holes line up. **NOTE:** Strike the casting directly over the pylon only. Binding or damage could otherwise result. Use a soft mallet only.

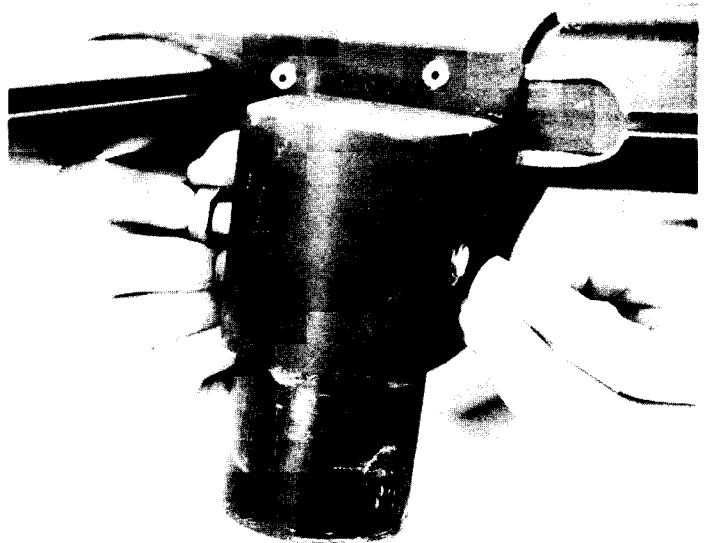

**FIGURE 7**

Once all the castings are properly positioned, install the pylon bolts and nuts, with the nuts inboard. Tighten securely, but do not over-torque.

# TRAMPOLINE

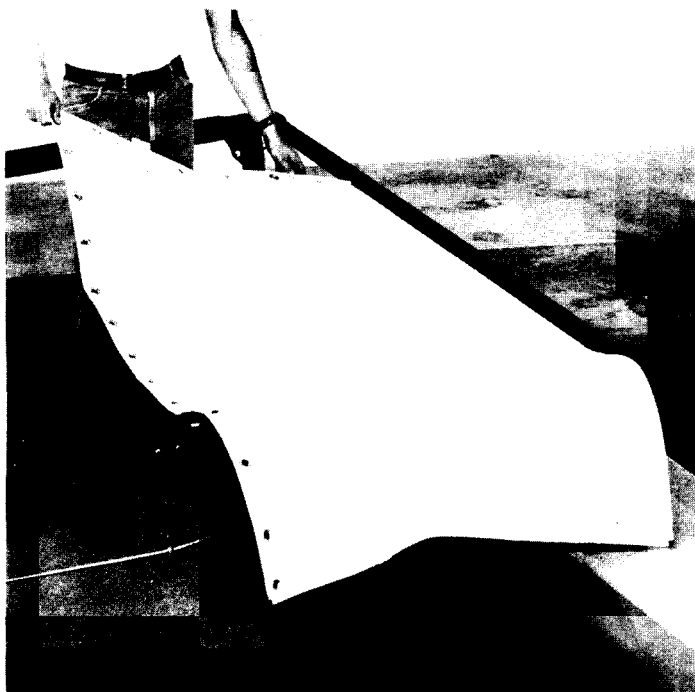

**FIGURE 8**

Insert trampoline half into the flared sidebar track so that the grommets are running down the center and across the back. The hiking straps should be on top. Position the forward edge even with the forward crossbar.

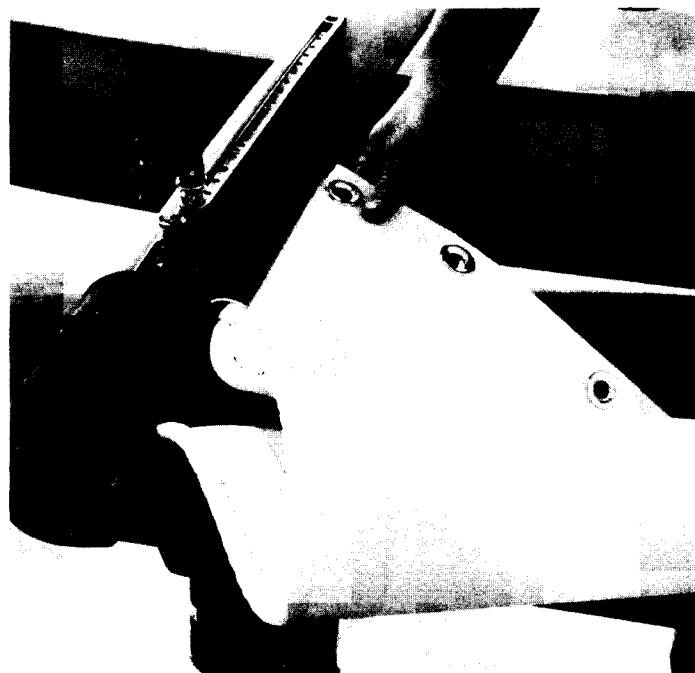

**FIGURE 9**

Insert the forward edge of the trampoline into the front crossbar track adjacent to the corner casting and slide it all the way to the center. Repeat steps 8 and 9 for the opposite side.



**FIGURE 10**

Install the aft lacing strip by feeding the larger bead into the track in the aft crossbar. Make sure it is centered.

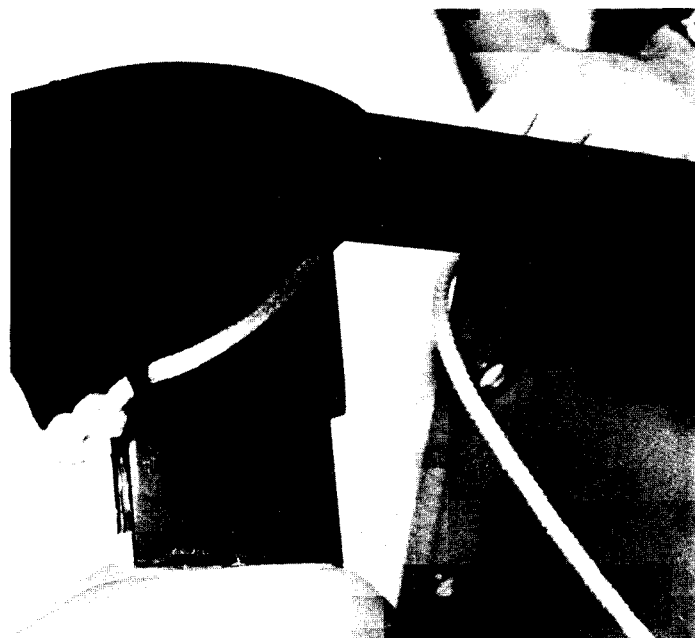

**FIGURE 11**

Tie each aft lacing line to the aft corner casting as shown.

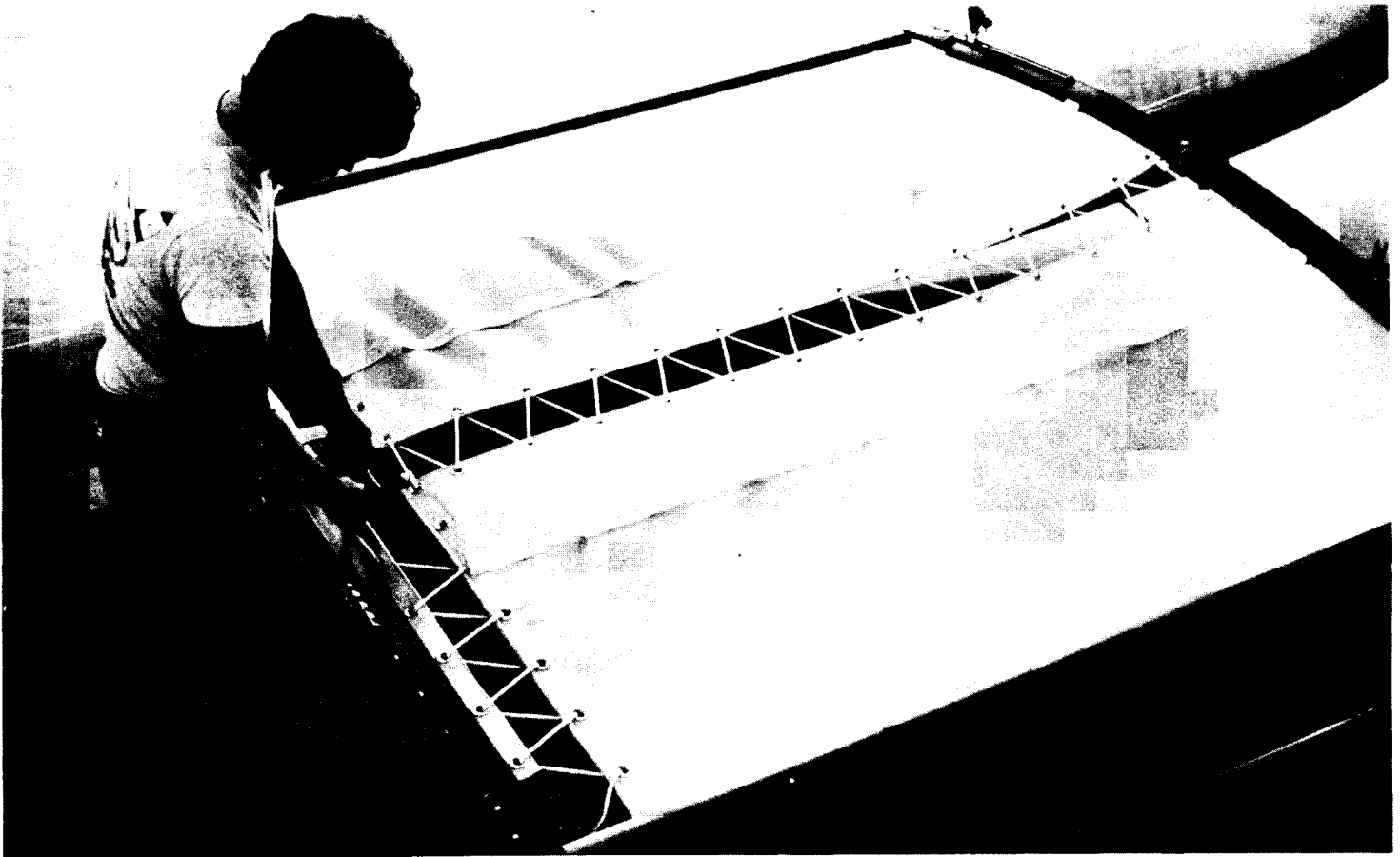

**FIGURE 12**

Tie the center lacing line to the forward grommet on the port (left) trampoline half. Lace the line back and forth, taking up slack as you go. Temporarily tie off the line at the aft end, then remove slack again by working it out front to back. Lace the two aft lines simultaneously in the same manner.

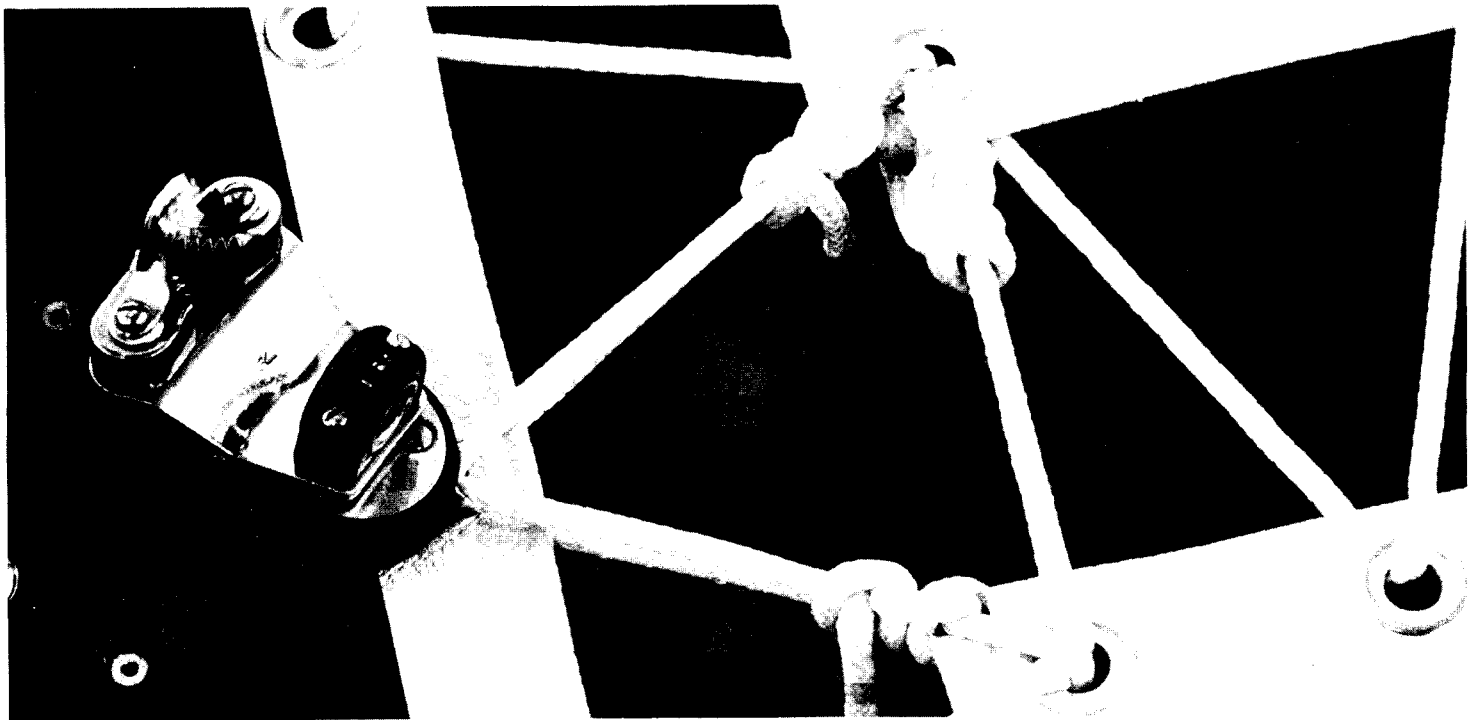

**FIGURE 13**

Once the trampoline is laced as tightly as possible, re-tie all the lines as in Figure 13. Use up any excess line by tying several hitches as shown. As the boat is used, it will be necessary to periodically retighten the lines.

## RUDDER & TILLER SYSTEM

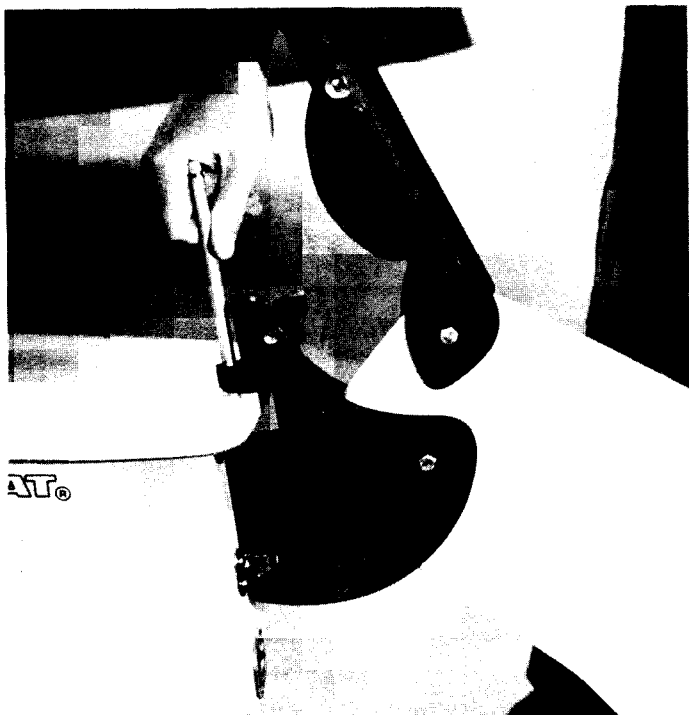

**FIGURE 14**

Install the left rudder assembly onto the transom of the left hull. The nylon nuts will be facing inboard. With the tiller arm held out of the way, slip the rudder pin — cotter key up — down through the casting and gudgeons. Once in place, install the other cotter key into the rudder pin below the casting (see Fig. 15). Repeat with right rudder.

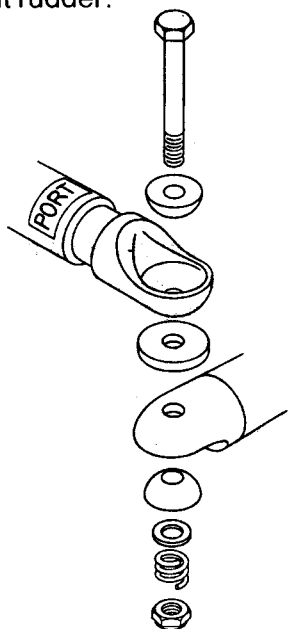

**FIGURE 16**

The illustration shows an exploded view of the tiller connector kit. Notice that it depicts the port (left) side. Install the tiller crossbar with the "PORT" sticker to the left side of the boat.

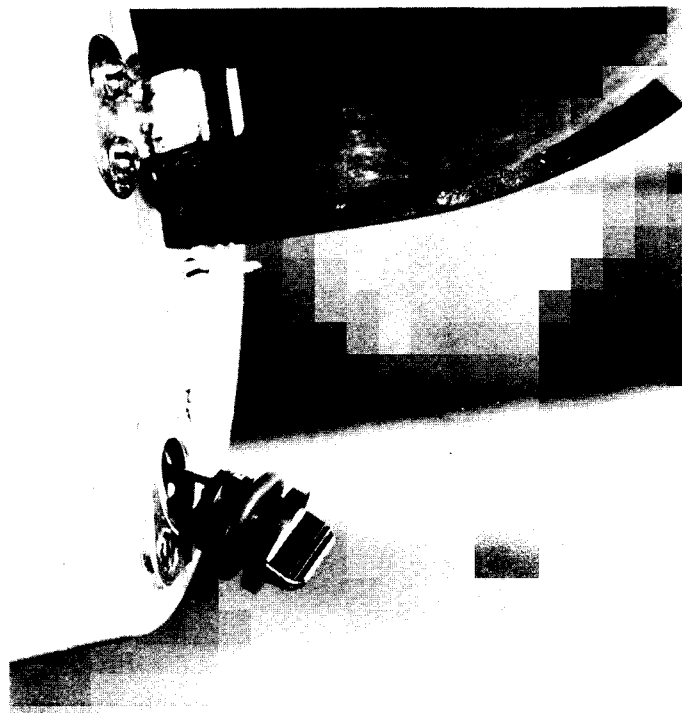

**FIGURE 15**

Install the drain plugs into their housings in each transom. Make sure that the O-ring gaskets are properly in place.

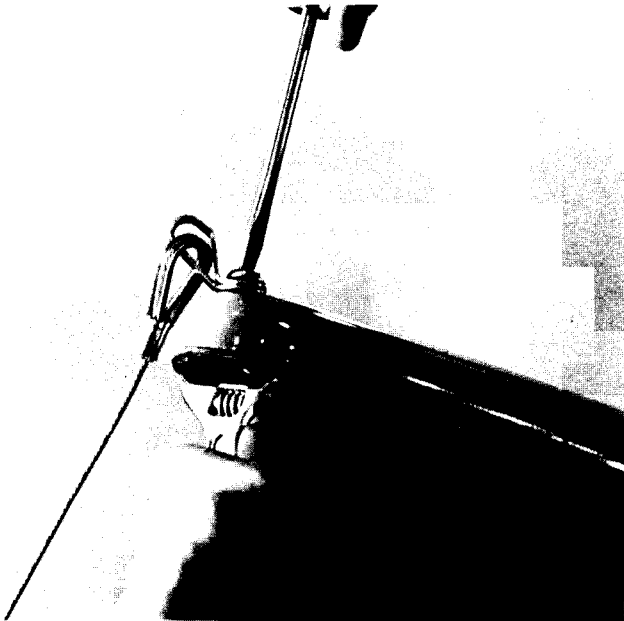

**FIGURE 17**

Tighten the nuts until the bolts protrude about two thread widths beyond the nylon locking elements of the nuts.



## MAST & RIGGING



**FIGURE 18**

Attach the bridle wires to the bow tangs by removing the bolts and slipping one end of each bridle into its tang. Retighten the bolts.

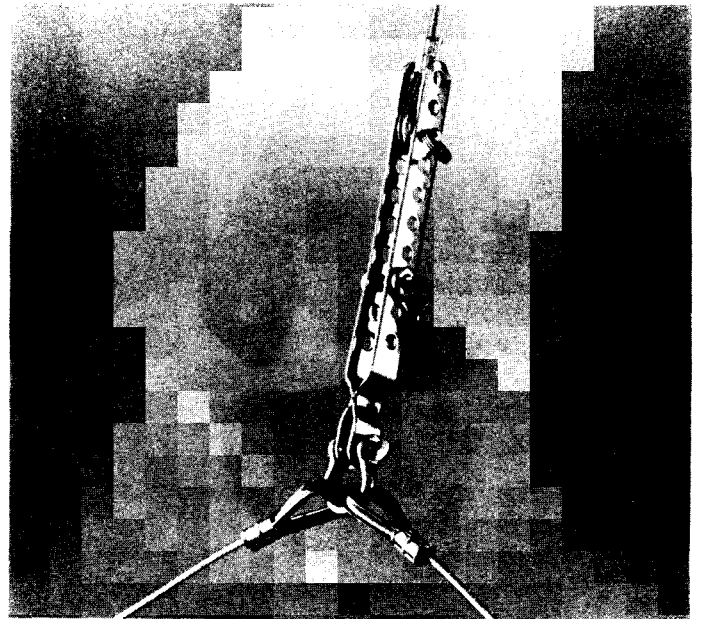

**FIGURE 19**

Attach the opposite ends of the bridles to the shackle on the bottom of the forestay adjuster.

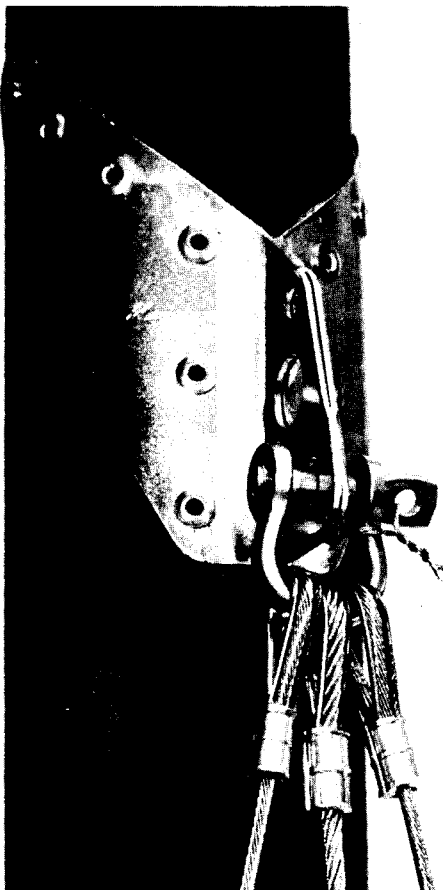

**FIGURE 20**

The forestay and shrouds are connected by a large shackle. Attach this shackle to the lower hole in the mast tang, insuring that the forestay is between the two shrouds. Tighten the shackle pin securely with pliers, then twist the safety wire around the shackle body and through the hole in the shackle pin.

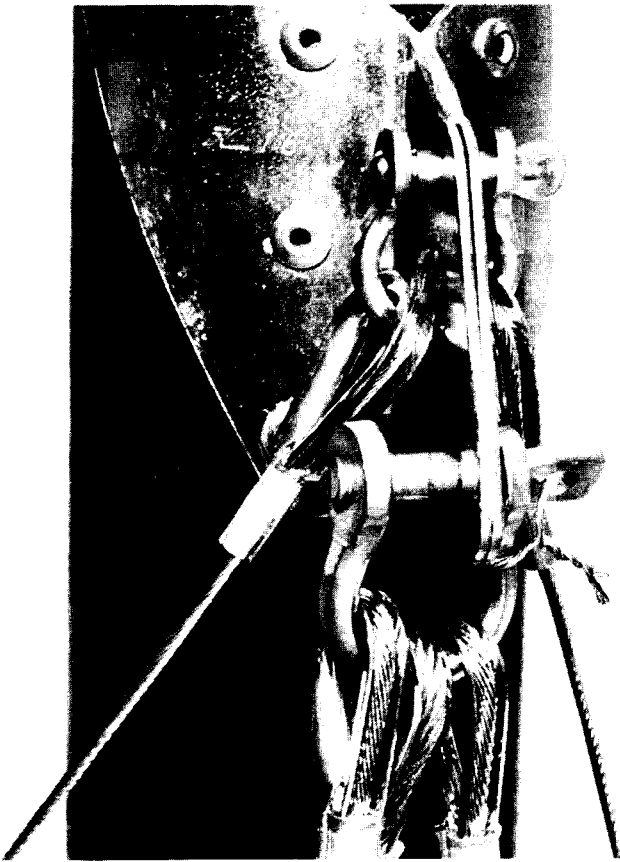

Using the shackle provided, attach the trapeze wires to the two upper holes in the mast tang as shown. Use the trapeze wire shock cord to tie the lower end of the wires to the mast during stepping. For sailing in areas of frequent strong winds, double trapeze rigs are available from Hobie Cat® dealers

FIGURE 21

To keep the jib halyard out of the way while stepping the mast, secure it at the cleat as shown.



FIGURE 22

## STEPPING THE MAST

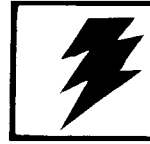
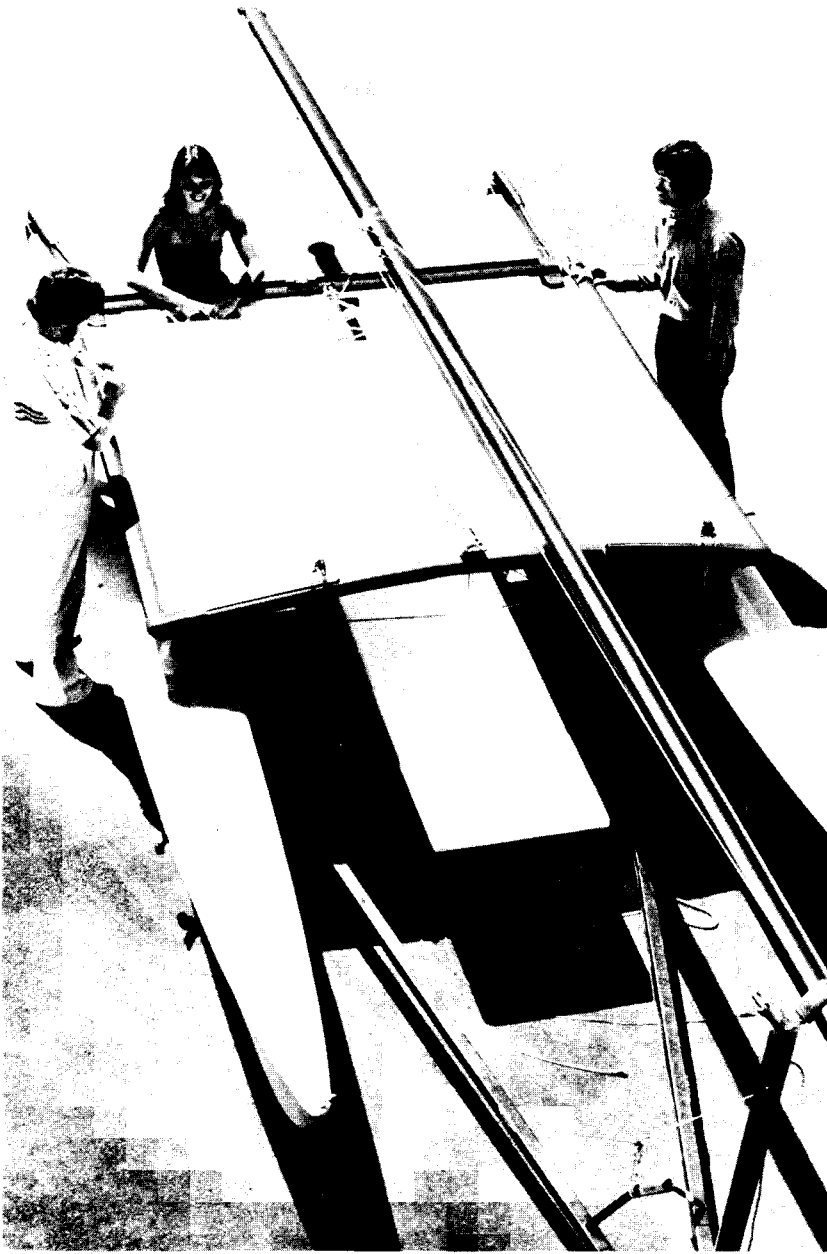

### **DANGER!!** **POWER LINES**

Do not attempt to step the mast in an area of overhead wires. A mast contacting an electrical wire could be fatal.

Lay the mast on top of the frame with the mast head aft. **Notes:** (a) With experience, the mast can be stepped by one person, but Hobie Cat recommends that you have someone assist you; (b) Position the boat facing into the wind, and on level ground. If the trailer is not attached to a vehicle, chock the wheels and have someone stand on the trailer tongue. **DANGER:** Do not raise the mast if overhead power lines are present.

THE HOBIE® CATS SHOWN IN THIS MANUAL MAY BE FITTED WITH OPTIONAL OR ACCESSORY EQUIPMENT.

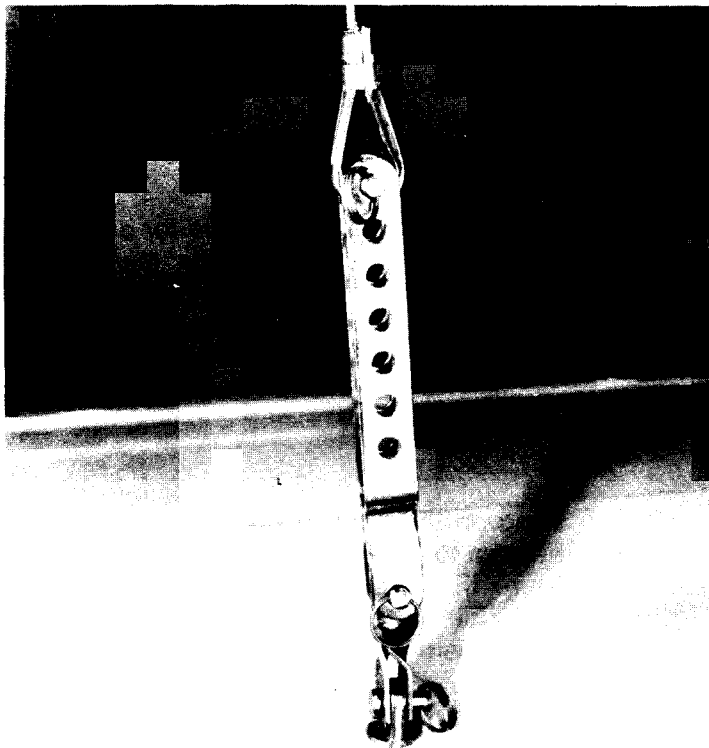

**FIGURE 24**

Attach the shroud stay adjusters to the anchor bolts on each hull with the clevis pins & lock rings provided. For initial assembly, attach the shrouds to the top holes of the adjusters, then reset as necessary to remove slack. **CAUTION:** Make sure that the shrouds are not crossed at the mast tang. Shroud failure and dismasting could result.

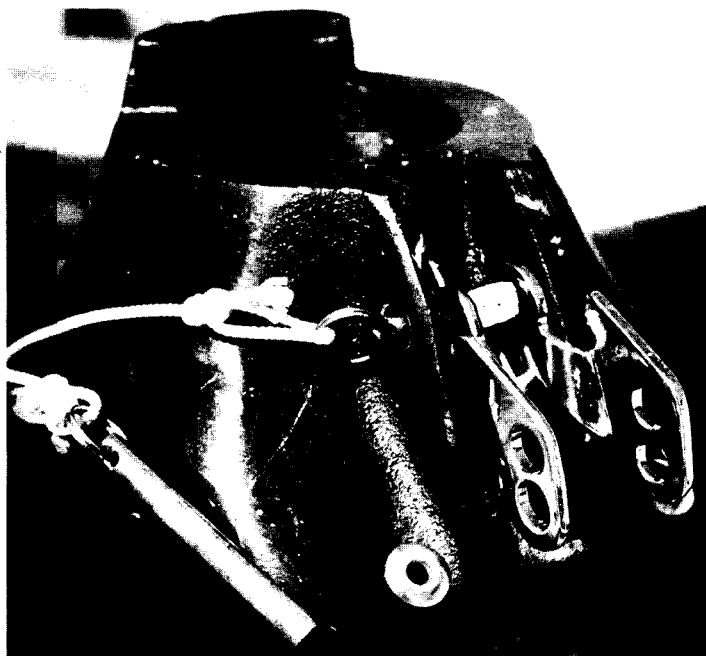

**FIGURE 26**

The mast step link should be attached to the mast step with the headed clevis pin and lock ring. Make sure the arrow points upward.

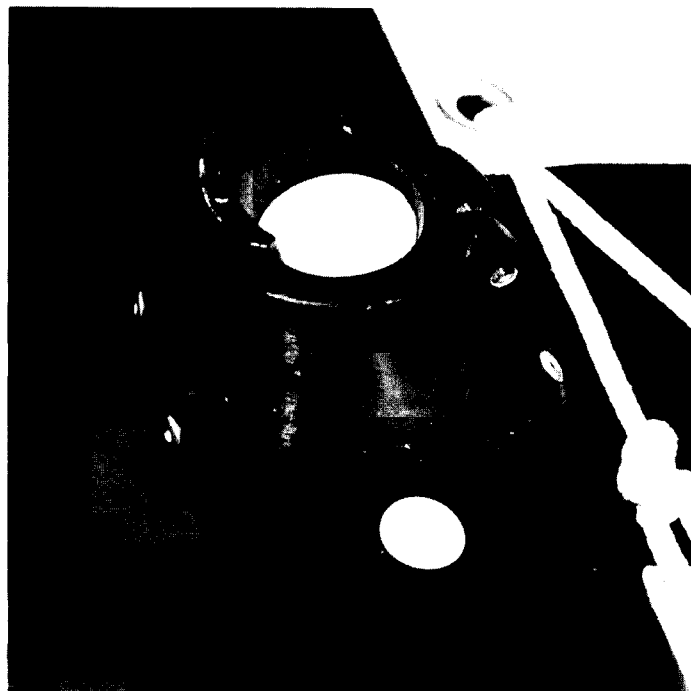

**FIGURE 25**

Place the mast pivot bearing in the mast step cup. **Note:** In trailering, remove the bearing to prevent losing it.



**FIGURE 27**

Using the headless clevis pin, fasten the mast base to the hole in the link marked "16". As you begin to raise the mast, the link will rotate upward. Once having begun, keep the mast from twisting, or the link could be damaged.

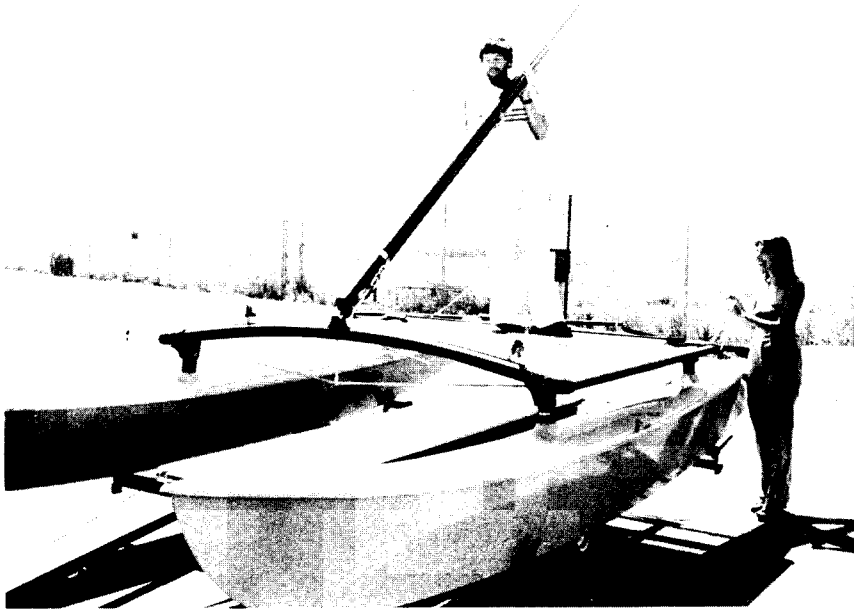

**CHECK FOR WIRES  
OVERHEAD . . .**

*. . . Check above at this time for overhead wires. Don't raise the mast if there are any wires.*

Stand on the rear crossbar and raise the mast to your shoulder. At this point, insure that the shrouds are clear of the rudders and rear corner castings. An assistant is recommended.

**FIGURE 28**



**FIGURE 29**

Walk forward, raising the mast as you go. At the full upright position, lean the mast forward against the shrouds and have an assistant attach the forestay. Later adjustment may be necessary.



FIGURE 30

Once the forestay is connected, the mast step link must be disengaged.

## TRAPEZE WIRES

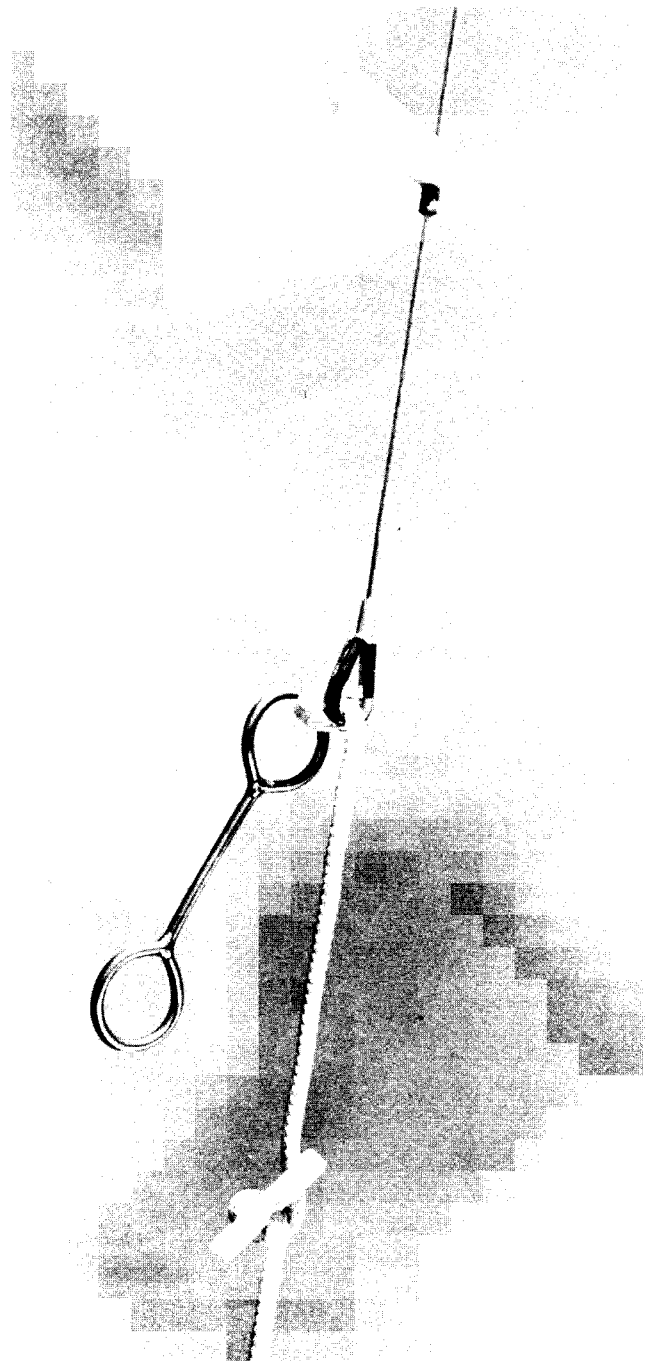

FIGURE 32

Trapeze assembly installed. **CAUTION:** Never allow the trapeze wires to carry any mast loads intended for the shrouds.

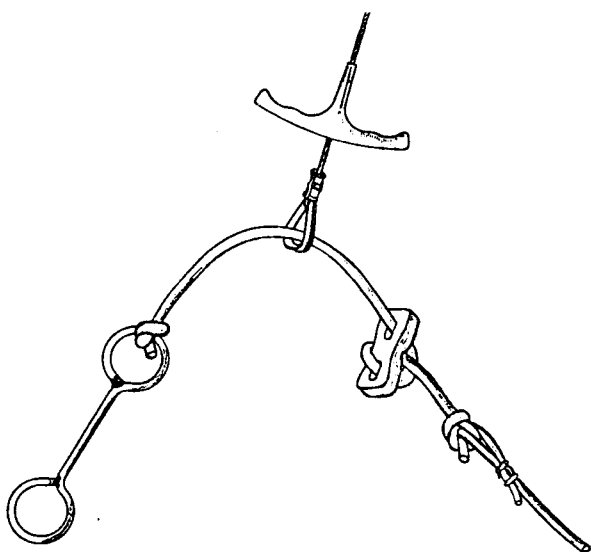
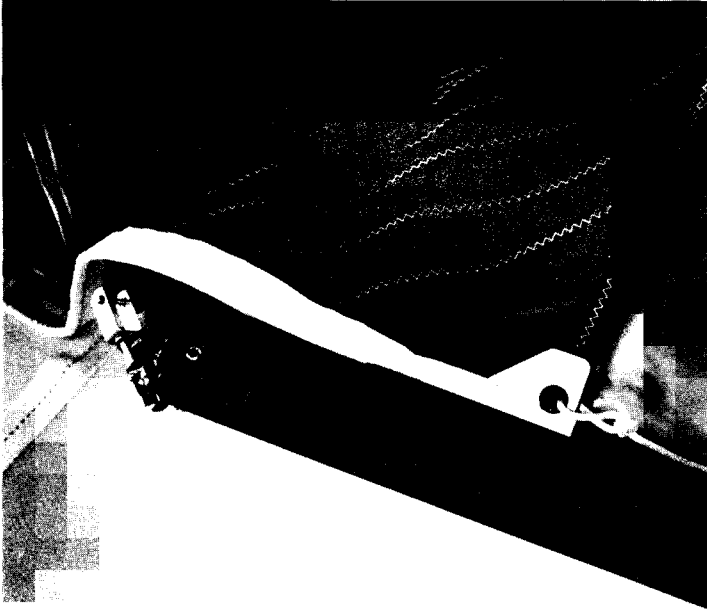

FIGURE 31

Assemble the trapeze adjustment components as shown in the illustration. The shock cord should pass beneath the trampoline frame from the port trapeze line to the starboard line. **Note:** Insure that these items are assembled exactly as above. Refer to knot diagram, "Bowline Knot," on page 2.

# MAINSAIL



**FIGURE 33**

Feed the foot (base) of the mainsail into the track opening in the forward end of the boom.

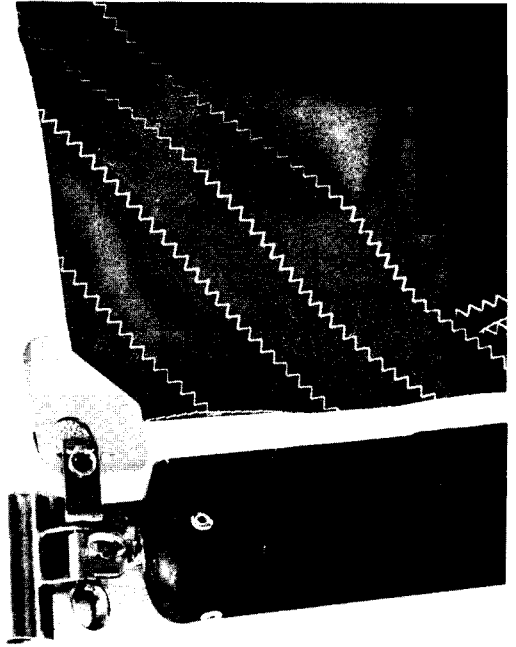

**FIGURE 34**

Attach the mainsail tack to the gooseneck shackle as shown.

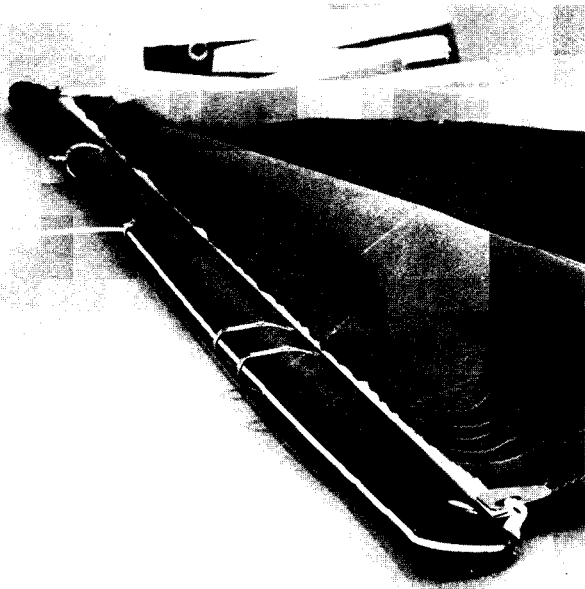

**FIGURE 35**

Tie the outhaul to the mainsail clew with a bowline knot. Lead it around the boom cap, through the block hangers, and through the outhaul jam cleat. Tie a figure eight knot in the end of the line.

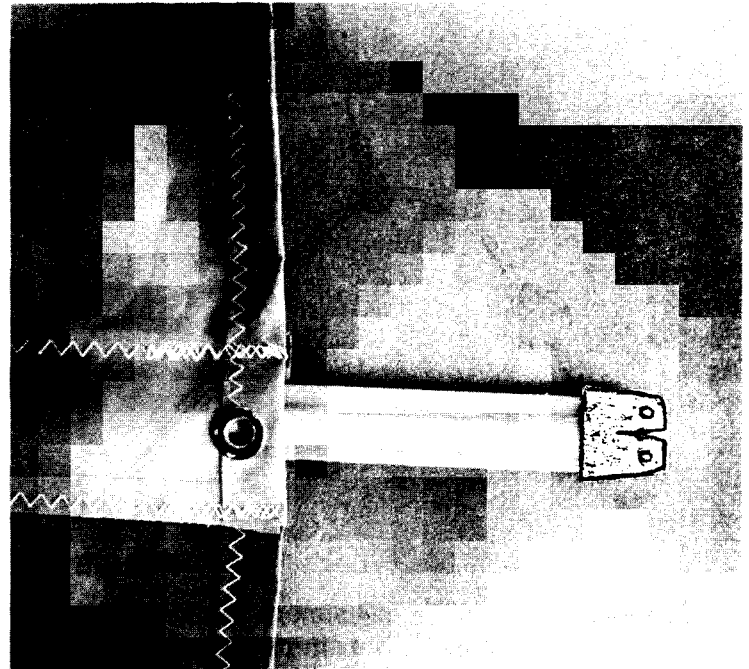

**FIGURE 36**

Insert each batten into its respective pocket, making sure it seats all the way into the batten pocket end protectors.

DIAGRAM - TYING DETAIL

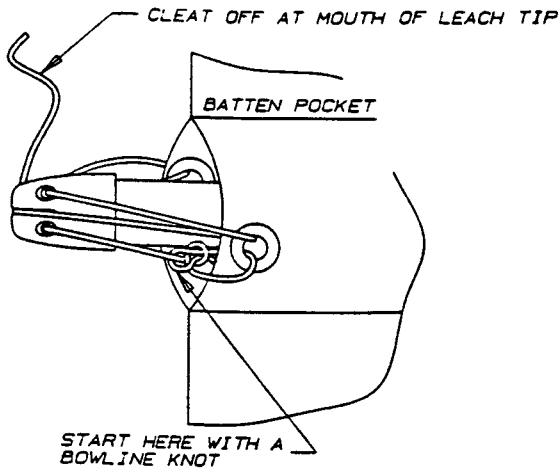

FIGURE 37

Photo illustrates recommended way to thread the batten ties. Batten tension can be varied to suit personal preference or sailing conditions.



FIGURE 38



Point the boat directly into the wind. Attach the halyard shackle to the head of the sail and feed the luff (leading edge) into the opening in the mast track. Continue pulling the halyard and feeding the sail into the track until it reaches the top.

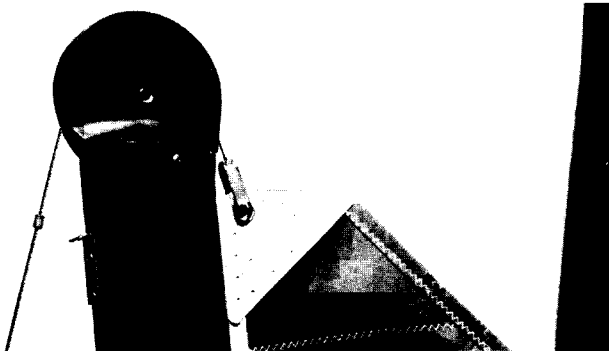

FIGURE 39



When the sail is all the way up, pull the halyard forward sufficient for the stop sleeve to clear the halyard hook.

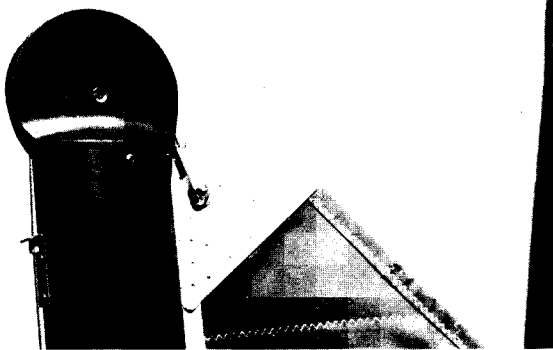

FIGURE 40

Once the sleeve is past the hook, position the halyard so that the sleeve will engage the hook when you release tension. That done, route the halyard from the front to the starboard side, and around behind the starboard shroud and trapeze wires. Secure it to the mast cleat and stow the excess line (see Figure 41).



## MAINSHEET SYSTEM



**FIGURE 41**

Insert the gooseneck into the mast track. Tie the downhaul line onto the ring and lead it through the cleat and ring as shown to provide multi-purchase leverage. Apply desired downhaul tension and cleat the line. **Notes:** (a) Do not re-insert the sail into the mast track below the track opening; (b) On a new boat, it is sometimes easier to adjust downhaul with the mainsheet system installed and sheeted in. Keep an eye on the wind.

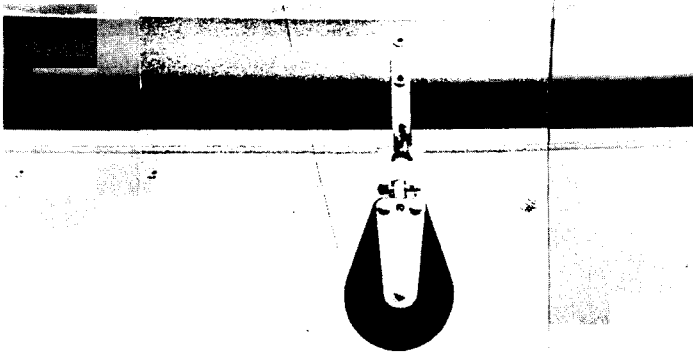

**FIGURE 43**

Shackle the boom blocks to the block hanger on the boom.

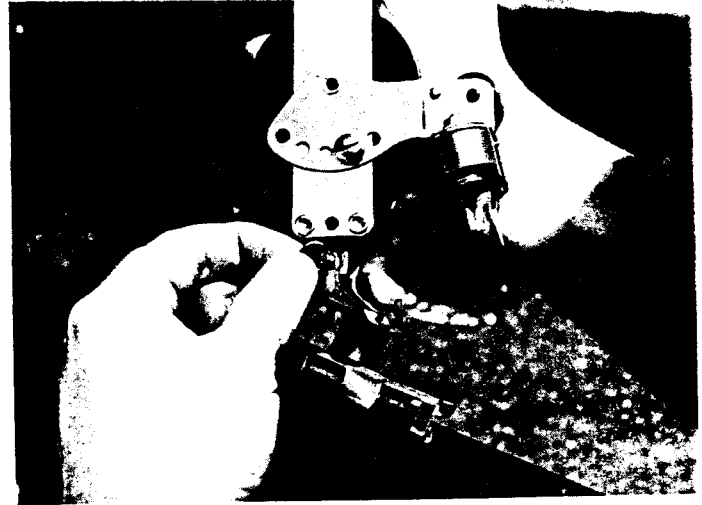

**FIGURE 42**

Attach the ratchet block to the traveler car

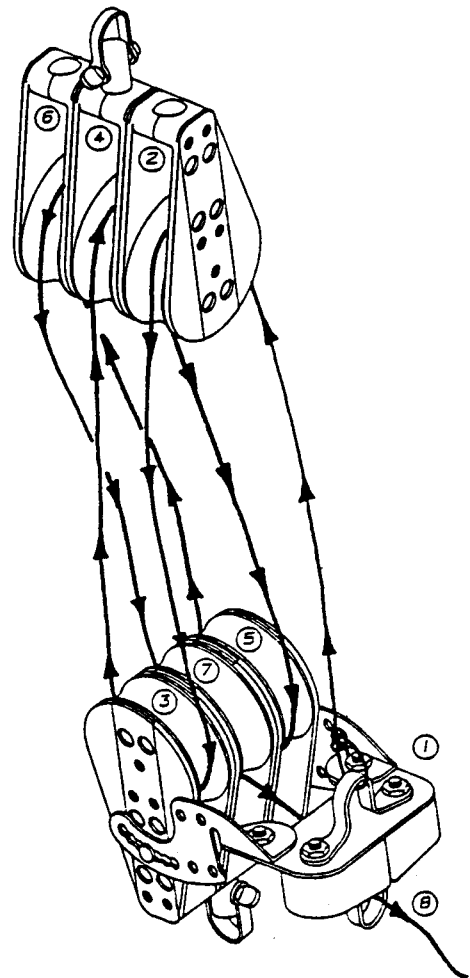

**FIGURE 44**

Install mainsheet line as shown.

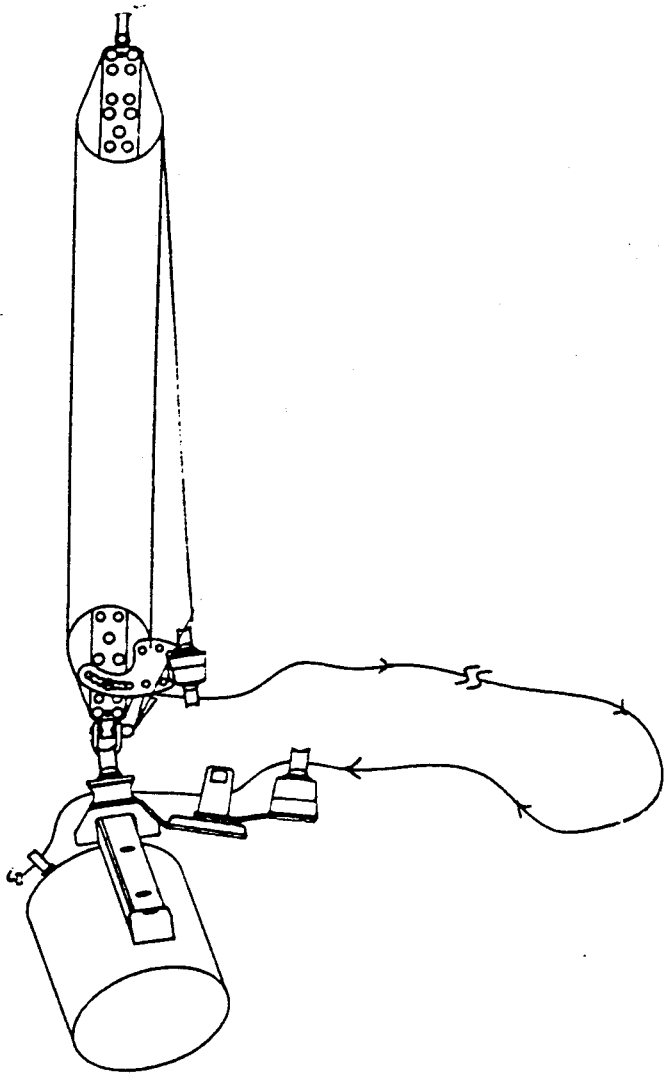

**FIGURE 45**

Run the free end of the mainsheet through the cam cleat on the traveler car, and the dead eye behind the cam cleat. Tie a figure eight knot to secure the line.

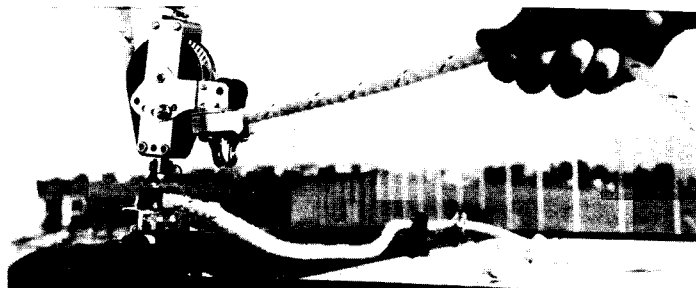

**FIGURE 46**

Mainsheet tension is held by pulling the mainsheet at an upward angle, which sets the line between the cam jaws.

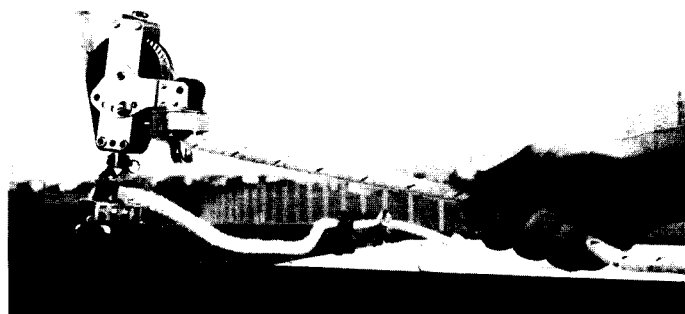

**FIGURE 47**

A quick, downward snap on the line will free it from the cam cleat, releasing tension. The traveler control works identically, but in the opposite direction. Before sailing, practice this until you are proficient.

# JIB SAIL

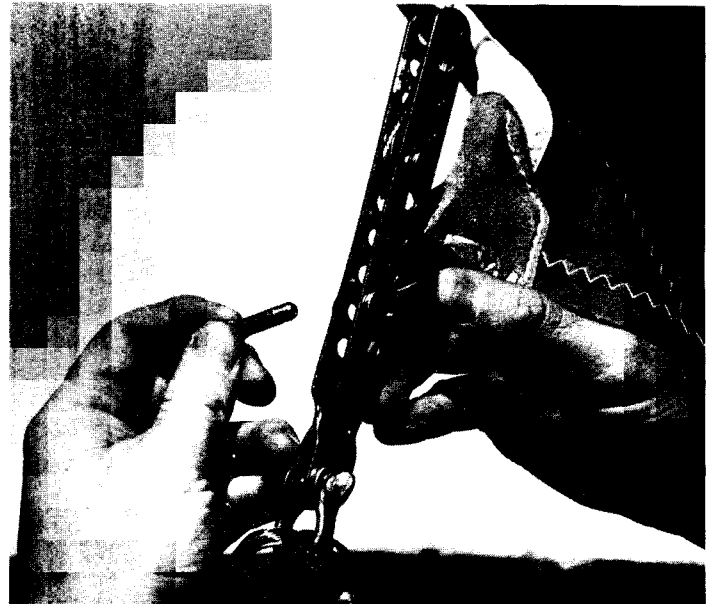

**FIGURE 48**

Install the jib battens (refer to Figure 36 & 37). Attach the jib halyard to the head of the jib and secure the plastic hank to the forestay by twisting it 90 degrees onto the wire. Raise the jib about 3/4 of the way and temporarily cleat the line.



**FIGURE 50**



**FIGURE 49**

Attach the jib tack to the shackle on the forestay adjuster.

Thread the jib halyard around the cheek block at the base of the mast, through the jib downhaul block, and around the cleat as shown. Raise the jib the remaining distance, then tension the line until there is about 4" to 6" of slack in the forestay. Secure the line to the cleat and stow the excess.

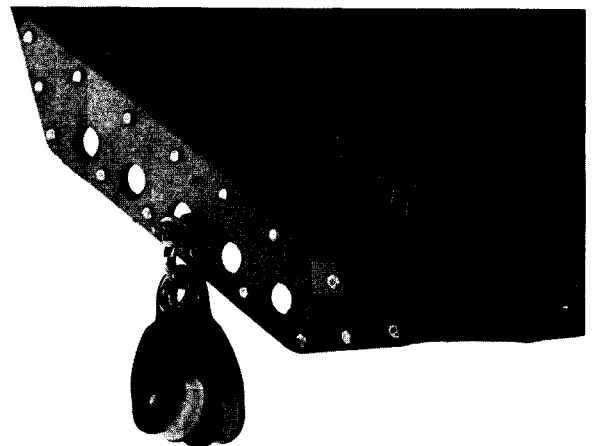

**FIGURE 51**

Shackle the jib clew blocks to the center hole of the jib clew plates. **CAUTION:** In windy conditions, do not allow the jib to flap at this step. The clew plate and attached blocks could cause an injury.

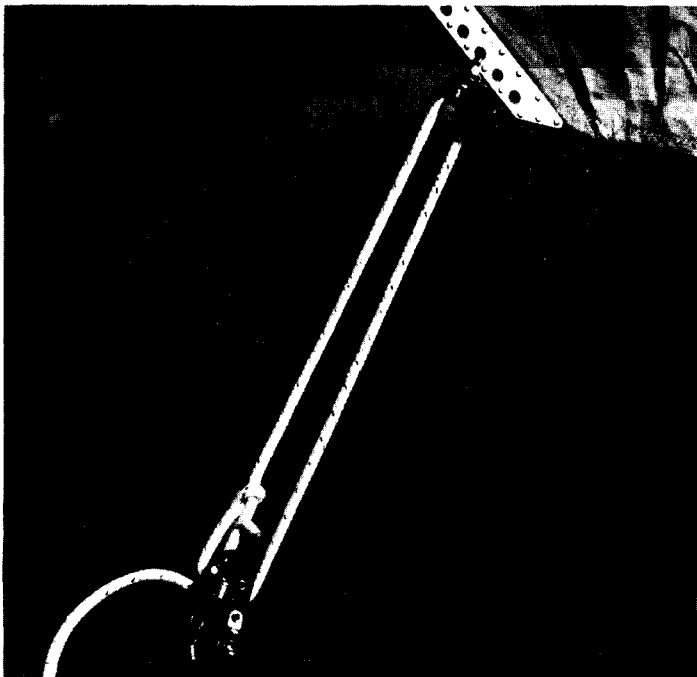

**FIGURE 52**

Tie one end of the jib sheet around the clevis pin in one of the jib sheet blocks. Lead it to the clew block and back through the cam cleat as shown.

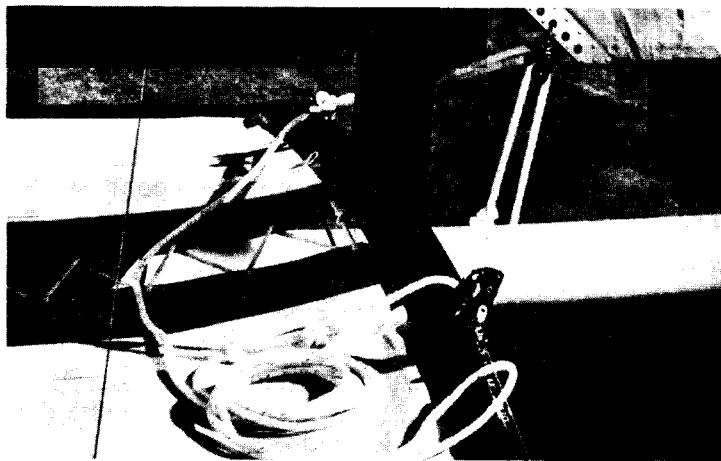

**FIGURE 53**

Lead the free end of the jib sheet to the opposite jib sheet block. Route it identically to the first side, but in reverse order. The cam cleats operate the same as those in the mainsheet system.

Re-check all shackles and clevis pin lock rings. (Please take this opportunity to read the safety section before sailing.)



Photo: Christopher Cunningham

**FIGURE 54**

Your Hobie® 16 is ready to sail.

# RIGHTING

Since it is predictable that you will eventually capsize your Hobie Cat® and because it can be assured that you will not have this manual for reference at the time (it will float away), please familiarize yourself thoroughly with what follows:

Always carry a 15 to 20 foot long righting line aboard your Hobie Cat® 16. One half inch diameter poly rope is recommended, and should be available from your Hobie dealer. The mainsheet can be used to right the boat in a pinch, but this adds unnecessary complication to the procedure as the sheet must first be removed from the mainsheet block system. Stow the line aboard in such a manner as to allow immediate access whether the boat is on its side or completely inverted (turtled). One popular method is to tie each end around the forward pylons, then wrap the excess loop around the dolphin striker.

It takes two people to right the Hobie 16. First, hang onto the boat as it capsizes. It doesn't normally turn over very fast, so holding on shouldn't be difficult. Avoid jumping or falling into the sail.

Second, uncleat the jibsheet, the mainsheet, and the mainsheet traveler so you won't be attempting to lift a sail full of water.

Next, tie the righting line around the shroud adjuster at its anchor point (chainplate) on the upper hull. If the boat is turtled, this will be the windward hull. Route the line over that hull and down (or over) to the opposite one.

Refer to the photos. Stand in the center of the lower, or leeward hull and hold onto the righting line, leaning back about 45 degrees or so.

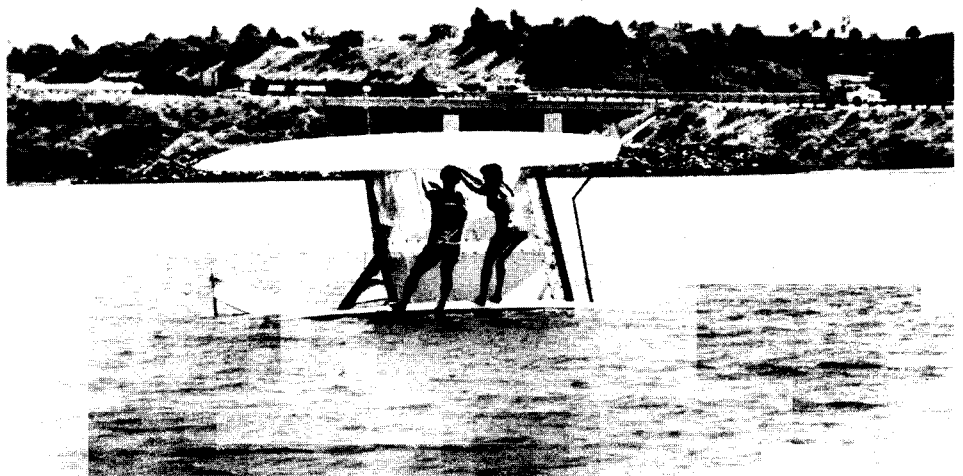

FIGURE 55

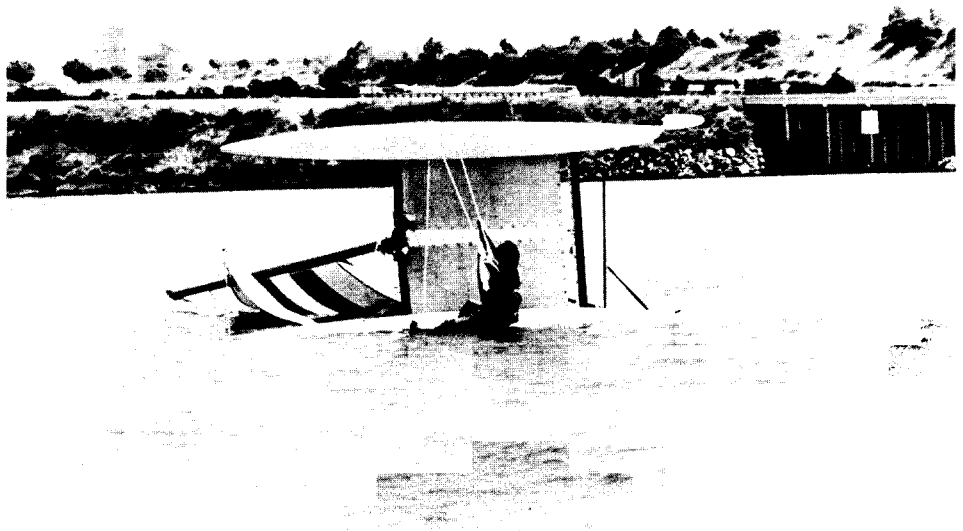
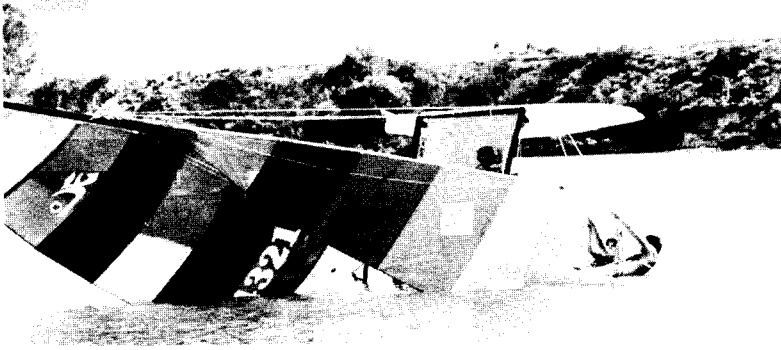
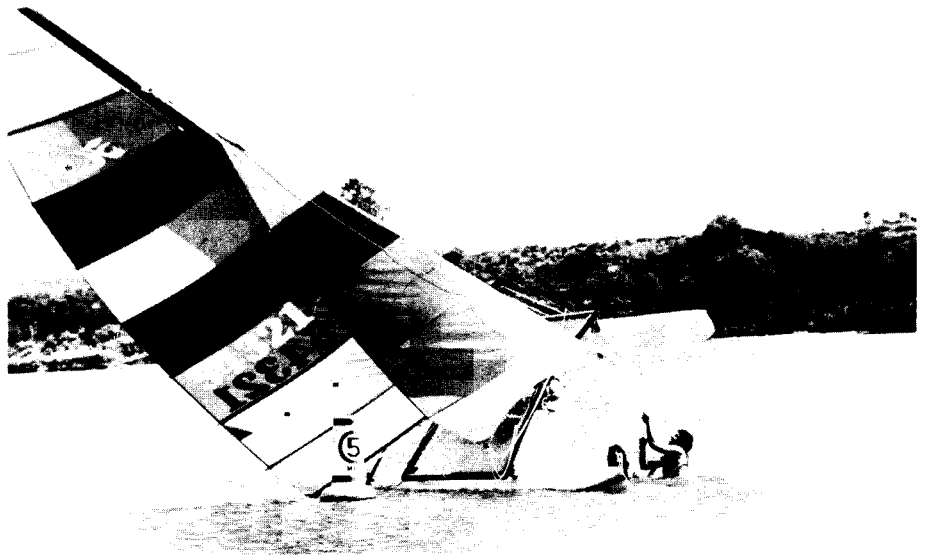

FIGURE 56



Helpful hint: Try to get the mast pointed into the wind so it will help you right the boat. This can be accomplished by shifting your weight to one end or the other and allowing the wind to “weathervane” the boat around. A mast-head that is stuck in a muddy bottom can be freed in like fashion.

FIGURE 57



Looking again at the photos, the combination of a helping wind, vigorous body english, and several seconds of patience will get your boat right side up.

FIGURE 58

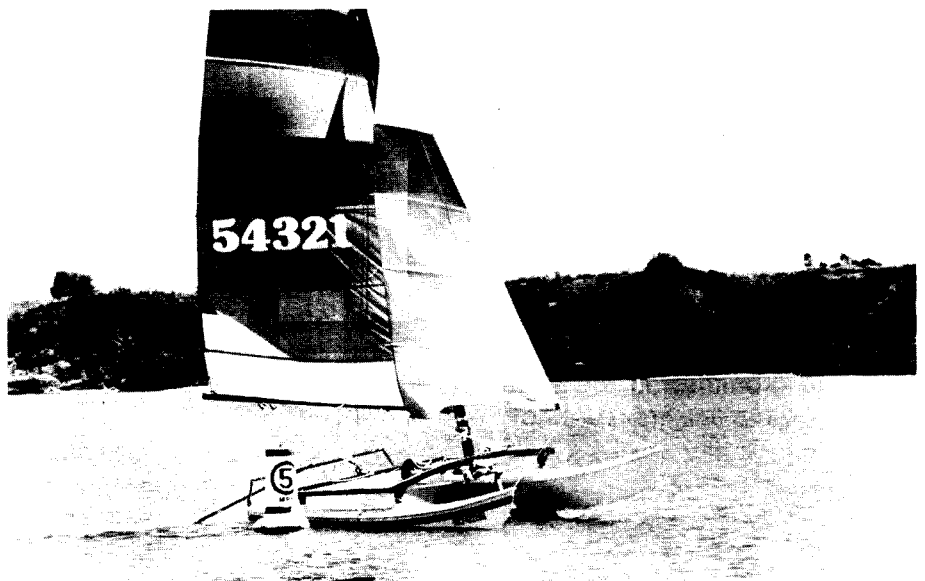

As it returns to upright, hold a hand up to prevent the hull from striking you when it comes down into the water. Also, it is **IMPORTANT** that you hang on to the righting line. Having successfully righted your boat will do no good if you allow it to sail away without you.

FIGURE 59

## TRAPEZE USE

The Hobie® 16 is equipped with a trapeze system for maximum speed and fun. You should become familiar with it prior to its use.



**FIGURE 60**

The trapeze seat components are assembled as shown, the hook always pointing downward. After the trap seat has been put on, run the lace lines through the grommet on the shoulder strap and tie the lines together in a figure 8 knot.



**FIGURE 61**

Adjust the trapeze line by moving the rope lock up or down to compensate for your height and the desired "hiking out" angle. The adjustment should not be such that the user is easily dragged through the water when sailing through waves, chop, etc. Sit on the sidebar as shown and connect the lower end of the dogbone to your trapeze seat hook.



**FIGURE 62**

Lean back, holding onto the plastic trapeze handle for balance, and ease yourself out by pushing away with your legs. Make sure that your weight is supported by the trap seat rather than by your "hanging" on the handle. Otherwise, the hook could become disengaged. DO NOT hook up and fall backwards out over the side. This could cause overstressing and failure of the trapeze line.

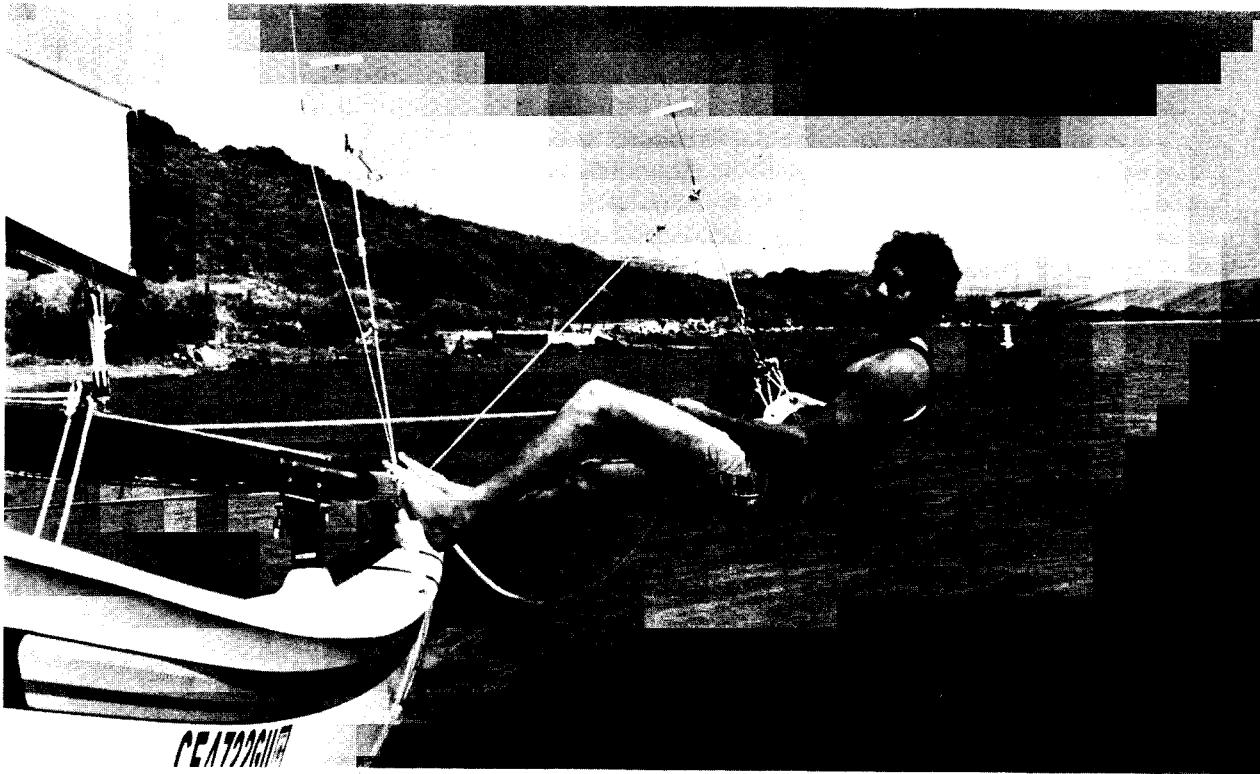

**FIGURE 63**

Maintain control of the tiller and sheets as you extend out into the trapeze position. Keep your feet about shoulder width apart and your knees slightly bent.



**FIGURE 64**

Trapeze system in use (Double Trapeze rig and Deluxe Trapeze Seats are extra-cost accessories). While using the trapeze, watch the opposite hull. Adjust for proper trim by shifting weight fore and aft; do not allow the leeward bow to submerge, or the boat may decelerate or stop abruptly, causing the occupants to be thrown forward still attached to the trapeze wire.



# SAFETY

## **IMPORTANT: READ BEFORE SAILING**

While sailing is generally a safe sport, carelessness or lack of knowledge can be dangerous. A little common sense and attention to a few precautions go a long way toward protecting your safety in anything you do, including sailing.

### 1. LIFEVESTS

In the first place, don't sail without a Coast Guard approved life vest or jacket for each person on board. A Type 1 PFD is an approved device designed to turn an unconscious person in the water from a face downward position to a vertical or slightly backward position, and to have more than 20 pounds of buoyancy, recommended for off-shore cruising and acceptable for all size boats. If you're sailing in any kind of a heavy sea or strong winds, you should have your life jacket or vest on. Accidents do happen occasionally, even to the best of swimmers, and when they do, they usually happen quickly. Also remember to have an adequate paddle and righting line on board at all times, along with one type 4 throwable flotation device.

### 2. OFF SHORE SAILING

*Don't sail far out to sea. Weather conditions can change rapidly and even if you're an experienced sailor, old Mother Nature can sometimes get the best of you. You should never sail alone where you can't find shelter within a fairly close range or at least summon assistance.*

### 3. EQUIPMENT

Know your equipment! The \_\_\_\_\_ is built of quality materials and requires little maintenance, but for safety's sake, you should inspect it occasionally. Check the seals in your mast by pushing it underwater and watching for air bubbles. If it is leaking, have it resealed. A mast full of water makes righting a capsized boat awfully difficult. If you find the hulls are taking on an appreciable amount of water, check the foam plugs in the pylons by removing the trampoline frame. If leakage continues, check the through-hull fittings (screws) and apply silicone rubber sealant, if necessary.

### 4. WEAR AND TEAR

*"Check your shroud anchor pins, rudder pins, tiller arm connections, and tiller extension swivel. They will become worn with continued use. A little preventive maintenance can prevent a failure on the water.*

### 5. PRE-SAILING CHECK OUT

When you're stepping the mast, tighten your shackles with pliers. These can't vibrate loose if they're cinched down tightly. If one of these comes loose while sailing, you risk damaging the boat or even being hit by a falling mast.

### 6. ELECTRICAL DANGER

***Watch for low overhead electrical wires whenever you are sailing or trailering with the mast up. The mast sticks up there a long way and shock or death could result if it should come in contact with overhead wires. So look up when moving the boat around and give any wires a wide berth.***

The Hobie Cat® will give you so many hours of trouble-free sailing that the tendency is to forget to look at any of the hardware until something wears out completely. Make it a habit to check the boat out each time before you sail.

### HOBIE CLASS ASSOCIATION

The Hobie Class Association was started by a group of Hobie owners who got together back in 1968 to organize some racing and other activities. Hobie was the mainstay of the group promoting the activities himself. At that time, it wasn't really a class association but simply a group of owners wanting to have fun with their new toys. Hobie would write brief news letters from the factory announcing regattas as they developed across the country. He published a set of class rules rigidly restricting changes and modifications which can be made to the boat. As the class started to grow, people were hired to help administer the program. At that point, the association became a little more formal: the groundwork for the establishment of fleets was developed and the Hobie Cat-Hotline was initiated as a class newsletter.

The Class Association was originally organized around one basic consideration: to extend each Hobie owner's enjoyment through organized, family oriented activities. Innovations were made in racing procedures and the regatta structures. A policy of including the whole family in the activities developed to assure everyone would have fun at a Hobie regatta. The Association continually strives to develop better programs so owners may further enjoy their Hobies.

# HOBIE CAT 16'

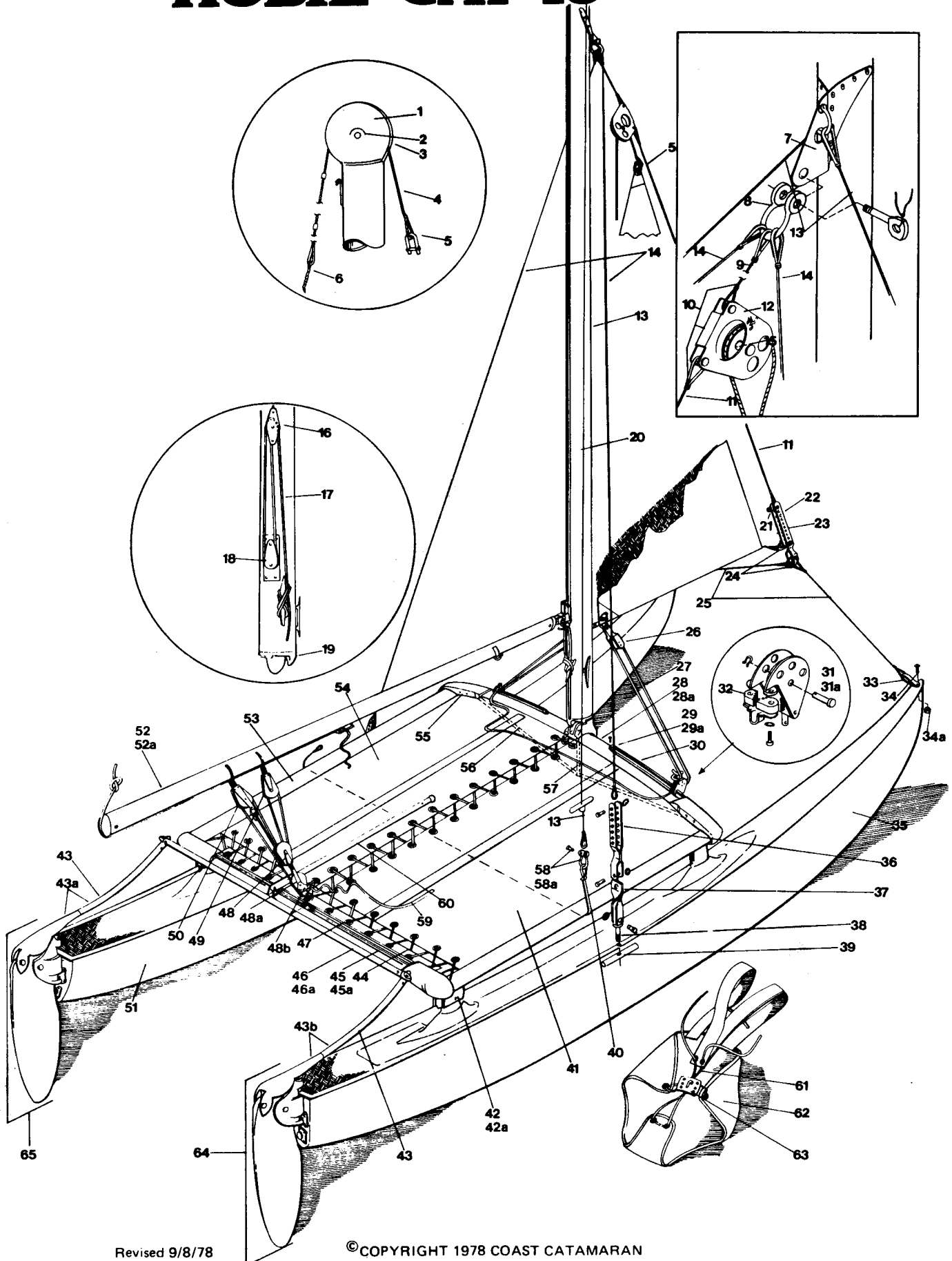

Revised 9/8/78

© COPYRIGHT 1978 COAST CATAMARAN

# HOBIE CAT 14',16'

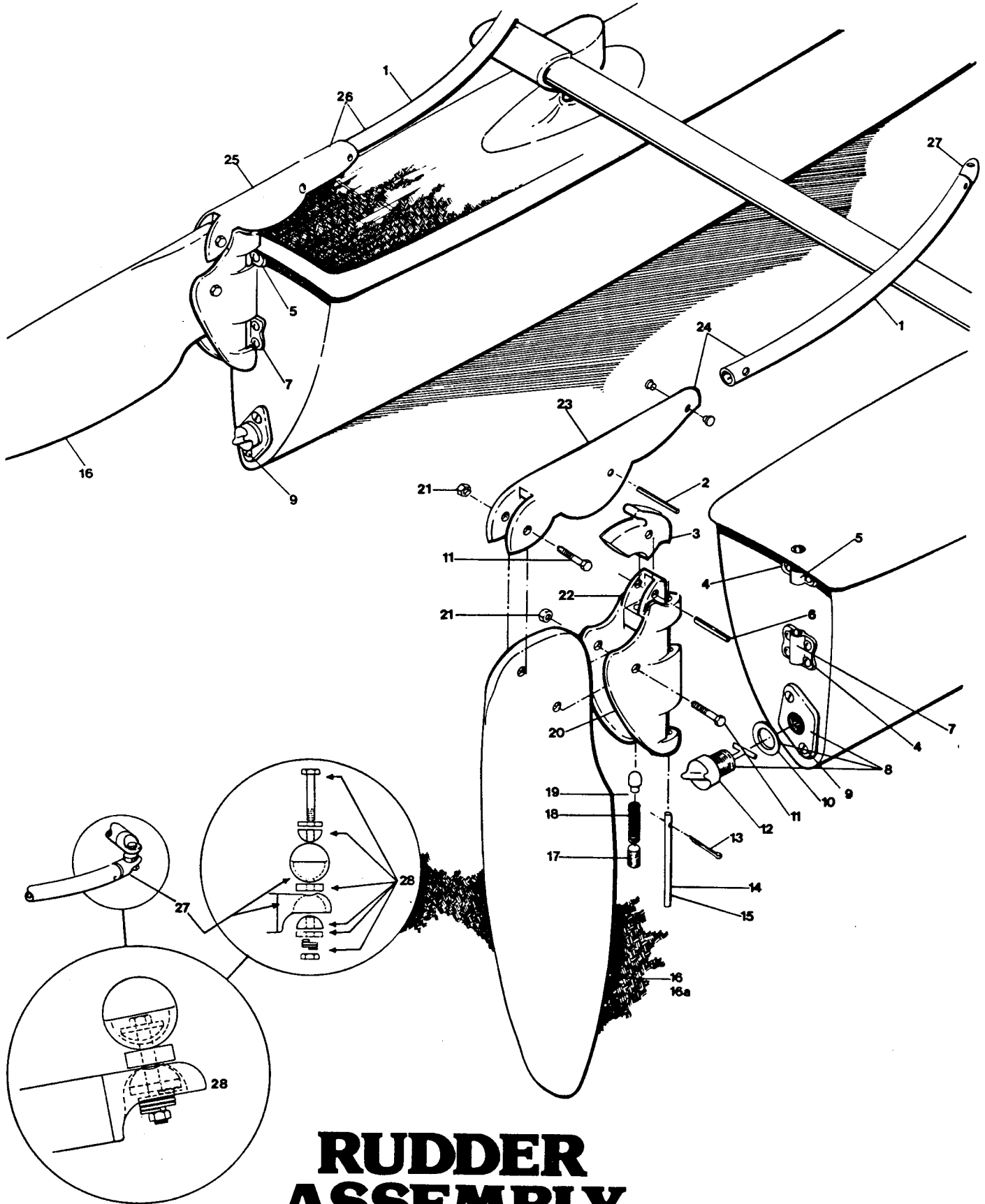

## RUDDER ASSEMBLY

Revised 9/8/78

© COPYRIGHT 1978 COAST CATAMARAN

# HOBIE CAT 16'®

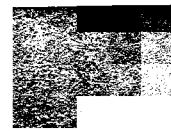

INDEX NO.	DESCRIPTION	INDEX NO.	DESCRIPTION
1	Mast head assembly	40	Shock cord
2	S.S. sheave pin	41	Trampoline right half (white)
3	Nylon sheave	42	Bolt, 1/2"
4	Main halyard wire w/shackle	42a	Nylon nut, 1/2"
5	Main halyard shackle	43	Tiller arm (bent)
6	Main halyard rope	43a	Rudder arm (left)
7	Mast tang	43b	Rudder arm (right)
8	Shroud shackle, 5/16", packaged	44	Trampoline lacing slide white
9	Pigtail kit, upper section, packaged	45	Rear crossbar assembly
10	Forestay assembly, both sections	45a	Rear crossbar (bare)
11	Forestay, lower section w/jib hlyd block	46	Tiller crossbar assembly with tiller ext.
12	Jib halyard block assy.	46a	Tiller crossbar w/endcaps no ext.
13	Trapeze wires w/handles, one pair	47	Traveler track
14	Shroud	48	Double block
15	Jib halyard wire w/shackle	48a	Ratchet block assy.
16	Jib downhaul block	48b	Ratchet block replacement jaws
17	Jib halyard rope	49	Boom block
18	Jib downhaul cheek block	50	Boom block w/becket
19	Mast base	51	Hull/port
20	Mast assembly	52	Boom assembly
20a	Mast extrusion (plugged but bare)	52a	Boom extrusion
21	Adjuster ring	53	Side bar
22	Adjuster pin, 1/2"	54	Trampoline, left half white
23	Forestay adjuster, 10 hole	55	Striker rod hex nut
24	Shackle, 1/4"	56	Striker rod 5/16" x 7'
25	Bridle, wires, both sides	57	Dolphin striker post
26	Jib clew block	58	Shackle bell
27	Jib sheet line	58	Shackle pin
28	Front crossbar assembly	59	Main sheet line
28a	Front crossbar (less castings)	60	Tiller extension w/hinge
29	Jib traveler track stops	61	Trapeze lacing line
29a	Screw, #8 x 1" flathead	62	Trapeze seat complete
30	Jib traveler track	62a	Trapeze seat only
31	Jib sheet block w/car	63	Trapeze hook
31a	Clevis pin	64	Rudder assy (right)
32	Jib block cam jaws (pair)	65	Rudder assy (left)
33	Bow tang	37	Toggle
34	Screw, 5/16" - 18 x 1-1/4 RHMS	38	Anchor pin
34a	Nut, 5/16" s/s	39	Anchor bar
35	Hull/starboard (special order)		
36	Stay adjuster		

## HOBIE CAT 14' & 16'® RUDDER ASSEMBLY

INDEX NO.	DESCRIPTION	INDEX NO.	DESCRIPTION
1	Tiller arm, bent	16	Rudder blade, A.B.S.
* 2	S.S. pin, 3/8" x 2" for upper rudder casting	16a	Lexan blade
* 3	Plastic cam	*17	Derin screw
* 4	12-24 x 1" R.H.M.S.	*18	S.S. spring
* 5	Upper gudgeon	*19	Plunger
* 6	S.S. pin, 1/4" x 1"	*20	Lower rudder housing (complete)
* 7	Lower gudgeon	*21	Nylon nut, 5/16"
* 8	Drain plug assy.	*22	Lower rudder casting (bare)
* 9	Screw, #8 x 1" flathead s.m.s.	*23	Top rudder casting (right)
*10	Gasket (bagged, 4 ea.)	24	Top rudder arm (right)
*11	S.S. bolt, 5/16" x 2-1/4"	*25	Top rudder casting (left)
*12	Replacement plug	26	Top rudder arm (left) - clear anodized
*13	Cotter pin	*27	Tiller end cap
14	Rudder pin, 14' (bagged) nylon	*28	Tiller connecting assy (pair) (bagged)
15	Rudder pin, 16' (bagged) aluminum	*29	Replacement kit (for tiller connecting assy) (pair) (bagged)

\* Interchangeable parts

## AN IMPORTANT MAINTENANCE PROCEDURE:

Any metal part when exposed to salt water, salt spray, or even salt air, no matter how well protected, can subsequently oxidize and become weakened. In designing and building the Hobie Cat® we have taken every care to slow down and therefore minimize the adverse effects of corrosion. The aluminum extrusions used on the boat are all anodized and our casting are coated with either coricone or acrylic, both protective coatings.

Nonetheless, no matter how thoroughly the metal is protected, corrosion can take place in time. Consequently, the following maintenance and inspection procedures are recommended.

1. If at all possible, you should wash down your boat with fresh water after using it in salt water to remove any salt which greatly accelerates corrosion when left to stand on any metal part.
2. Periodically inspect your boat's metal parts for chafing, scratching, notching or other signs of damage to the surface finish. Damage to the surface finish may remove the protective coating (anodizing, coricone or acrylic) thereby giving corrosive elements access to the bare metal.
3. In particular, any time your boat is subject to unusual stress, such as tipping over in the surf or hitting something at a high speed, you should thoroughly inspect it for signs of stress as this can accelerate corrosion.

### MOORING:

Mooring a Hobie® is not recommended as it will cause deterioration and discoloration of the hull. If, however, it has to be moored for a short time the main things to remember are to make sure everything is snug and secure, and that the hulls are protected as much as possible against gelcoat deterioration.

A good anti-fouling paint can be applied for some protection from marine growth before mooring. Before painting, it is suggested that the area be masked off to ensure a clean line. No friction reducing paints or agents may be employed on a Hobie Cat® during competition.

Obviously the first thing to do is tie the boat securely to the mooring. Then furl the sail and secure all gear so it can't chafe when swells and boat wakes rock and thrash the boat. Last, but very important, be sure all shrouds are tight so the mast can't flop and fatigue the wires in the shrouds. Many an unsuspecting boat owner has moored his boat for a few days only to return to find his mast laying in the water. The easiest way to tighten the shrouds is to run a

line around a shroud, under the boom and around the other shroud. Tightening this line will tighten the shrouds and minimize fatigue and wear. Another method is to install a shroud tension adjuster (a single line tied to the bridle intersection and run through a cleat near the mast on the front cross bar). Tightening the shroud adjuster will tighten the shrouds.

### TOWING TIPS FOR THE HOBIE CAT® TRAILER SAILOR DANGER!

**Extreme caution must be observed when launching and sailing near overhead wires. A mast near a wire could be fatal!**

For a large percentage of Hobie Cat® boating enthusiasts, the boat trailer is an indispensable part of the boating picture. This vehicle makes it possible to enjoy new sailing scenes each weekend and most of all provide an inexpensive "mooring" for your favorite cat.

### SELECTING THE PROPER TRAILER

Two important needs should be considered in determining the proper trailer for your boat; the boat's need and your needs. First, the trailer should "fit your boat," allowing equal distribution of the hull weight.

Secondly, a trailer for a boat that is always hoisted does not need to be as elaborate as one that is used for water launching. In this respect, shallow shore slopes or unimproved launch sites may call for a "tilting," "breakaway" or an extending tongue trailer. A trailer that meets your boating needs make launching and retrieving enjoyable and safe.

### HITCHING YOUR TRAILER

Trailer hitches come in a variety of shapes and sizes. Most boat trailers connect to a ball hitch that is bolted or welded to the towing vehicle. Clamp-on-bumper hitches are not recommended for heavy loads or continued towing. Special heavy-duty equalizing hitches are a necessity for trailer tongue weights (the weight a loaded trailer places on the hitch of the towing vehicle) of 250 pounds or greater. The trailer hitch itself should match the size of the ball hitch: NEVER use a ball hitch that is too small. Solid steel ball hitches are preferable.

The coupling hitch on the trailer should have a lock or provisions to prevent loosening due to vibration. Lubricate the hitch for longer wear and quiet turns. The trailer should be equipped with at least one, preferably two safety chains. The chain must have a breaking strength of at least the gross weight of the trailer; solid link chain is best. Safety chains should be connected to the frame of the towing vehicle whenever the trailer is in use.

**CAUTION: Boat and mast should be securely attached to trailer with adequate tie down straps. Failure to do so could cause extensive damage or serious injury!**

#### LOADING YOUR TRAILER

The weight of the boat, equipment and additional gear should never exceed the manufacturer's rated weight capacity. Proper distribution of the load is of vital importance. Too much weight on the hitch will cause "tail dragging" of the towing vehicle, impairing steering and raising headlights into the eyes of oncoming traffic. Too little or negative weight on the hitch, and the trailer will sway or "fishtail". The solution to proper distribution is often adjusting movable gear.

#### TOWING

Extra caution is necessary when towing any trailer. The heavier the rig, the more time required to accelerate, pass, and stop. For this reason, the maximum speed for vehicles with trailers is less than without a trailer in most states. A long rig requires a larger turning radius. Curbs and obstructions should be given wide clearance. Most boats on trailers obstruct the rear view of the driver. When this happens, an additional rear view mirror on the right side of the towing vehicle is required by law. The trailer boatman should be familiar with traffic and highway laws relating to the towing of trailers. Towing a Hobie® has particular hazards that should be mentioned. A Hobie® is very wide. Obstacles should be given plenty of room when you are passing them. For long distance towing to prevent excessive drag, or in areas exposed to strong or gusty winds, the trampoline should be unlaced and rolled around the side rails to prevent the boat and trailer from being blown over. Hobie® tie down straps or lashings should be of sufficient size and diameter and placed on all four corners.

The mast support on a trailer is subject to a lot of side-to-side motion and consequently may fatigue where it is welded to the trailer. All this can be reduced by tying a line from each bow to the mast support. This will stiffen the rig up and prolong the life of the trailer.

#### LAUNCHING AND RETRIEVING

Prepare boat for launching at the top of the ramp or parking facility. Remove all tie-down straps, check boat plugs and fasten boat painter. Do not release winch line until boat is in the water. Back trailer to the left if possible; backing left gives better launching visibility. Avoid dunking wheel bearings wherever possible. Never leave the towing vehicle unattended on the ramp with only the parking brake

set. If vehicle must be left while on the ramp, set transmission in "park" or first gear, in addition to the parking brake. In retrieving your boat, make sure that the boat is properly placed on the trailer. Pull trailer up steadily to prevent spinning the wheels.

#### MAINTENANCE

**Lights:** Most state laws require two red taillights on the rear that may be combined with the stop and turn signals. Vehicles over 80 inches in width require clearance lights. If lights are dunked, waterproof light fixtures should be used. If water is allowed to enter, the lamp may crack and short out the entire system. Water also promotes contact corrosion. Always carry spare lamps. The wire coupling to the towing vehicle should be high enough to stay dry. Never rely on the trailer hitch for ground connection. Four-pole connectors should be used.

The Hobie® mast should not extend over three feet behind the rear light assembly. The ideal mounting is with the rudders up and the lights mounted to the tiller castings, if allowed in your area.

On a van rack combination the rear end of the mast should show a red light and flag, the front of the mast cannot extend over three feet forward of front bumper.

**Wheels:** Tires should ALWAYS be inflated to manufacturer's recommended pressure. Always carry a spare wheel and a jack that fit the boat trailer. If wheel bearings are always dunked, waterproof bearings and caps should be considered. If water is allowed into the hub, lubricating grease will float away and bearings will burn out or seize, causing damage and a safety hazard. Waterproofed bearings should be inspected prior to each boating season, others more often. Special care should be given when traveling on unimproved roadways with small diameter wheels.

If a spare wheel is not available, a spare wheel bearing set should be taken on long trips in case grease seal has been broken.

#### FRAME AND ROLLERS

Rust should not be allowed to accumulate. Remove rust and repaint with anti-rust paint. Some trailers offer galvanized coating to prevent rust. Rollers should roll freely, and should not have checks, breaks, or flat spots.

#### TOWING VEHICLE

Most vehicles are limited in towing capacity. Towing heavy loads places extra demands on the engine, transmission, brakes and other systems vital to the vehicle. Towing "packages" are available through most auto dealers and should be considered for heavy boats.

## HOWE & BAINBRIDGE, INC.

SYNTHETIC FABRICS  
COTTON FABRICS  
MOUNTAINEERING, BACKPACKING FABRICS  
SPECIALTY OUTERWEAR FABRICS  
COTTON DUCK  
FILTER FABRICS  
VINYL & NEOPRENE COATED FABRICS  
GOVERNMENT SPECIFICATION FABRICS  
SPECIAL EGYPTIAN FABRICS

220 COMMERCIAL STREET  
BOSTON, MASS. 02109, U. S. A.

TEL: 617 • 723-9000 • CABLE "HOWEBAIN"  
TELEX: 94-0597

BAINBRIDGE STABILIZED SAILCLOTHS  
BAINBRIDGE DACRON SAILCLOTHS  
BAINBRIDGE NYLON SAILCLOTHS  
FEATHERWEIGHT TENT FABRICS  
PARACHUTES & BALLOON FABRICS  
ACRYLIC FABRICS  
DESIGNERS OF INDUSTRIAL TEXTILES  
INDUSTRIAL SHEETING  
SAILMAKERS HARDWARE



### WET BLEEDING OF SAILCLOTHS

To prevent color transfer on your sails dry them as thoroughly as possible after using. Try not to store wet in sailbag for any longer periods of time than necessary.

When either dyed Nylon or dyed Dacron sail fabrics are stored wet, the color will bleed or transfer from the colored to the white or even from a darker shade to a lighter shade. The wetter and more compressed the fabric, the greater the bleeding – such as stuffed in a sailbag.

HOWE & BAINBRIDGE, INC.